

JVC

ENGLISH

DIGITAL VIDEO CAMERA

GR-DVL805 GR-DVL505

Please visit our Homepage on the World Wide Web and answer our Consumer Survey (in English only):

<http://www.jvc-victor.co.jp/english/index-e.html>

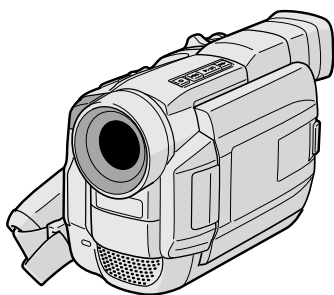

Mini **DV** NTSC
DSC
DIGITAL
STILL CAMERA

INSTRUCTIONS

For Customer Use:

Enter below the Model No. and Serial No. which is located on the bottom of cabinet. Retain this information for future reference.

Model No. _____

Serial No. _____

CONTENTS

AUTOMATIC DEMONSTRATION 7

GETTING STARTED 8 - 15

RECORDING 16 - 32

Basic Recording For Video 16

Basic Recording For
Digital Still Camera (D.S.C.) 19

Basic Recording For Video And D.S.C. 20

Advanced Features For
Video And D.S.C. 23

PLAYBACK 33 - 41

Basic Playback For Video 33

Advanced Features For Video 34

Basic Playback For D.S.C. 36

Advanced Features For D.S.C. 38

CONNECTIONS 42 - 45

Basic Connections 42

Advanced Connections 44

DUBBING 46 - 49

Dubbing To A VCR 46

Dubbing To Or From A Video Unit
Equipped With A DV Connector 47

Dubbing Images Stored In
The Built-in Memory To A Tape 48

Dubbing Images Recorded On A Tape To
The Built-in Memory 49

**USING THE REMOTE
CONTROL UNIT** 50 - 61

Slow-Motion Playback, Frame-By-Frame
Playback and Playback Zoom 52

Playback Special Effects 53

Random Assemble Editing 54

For More Accurate Editing 58

Audio Dubbing 60

Insert Editing 61

TROUBLESHOOTING 62 - 68

INDEX 69 - 75

Indications 69

Controls, Connectors And Indicators 74

USER MAINTENANCE 76

CAUTIONS 77 - 79

TERMS 80 - 81

SPECIFICATIONS 82 - 83

LYT0575-001B

EN

Dear Customer,

Thank you for purchasing this digital video camera. Before use, please read the safety information and precautions contained in the following pages to ensure safe use of this product.

Using This Instruction Manual

- All major sections and subsections are listed in the Table Of Contents on the cover page.
- Notes appear after most subsections. Be sure to read these as well.
- Basic and advanced features/operation are separated for easier reference.

It is recommended that you . . .

- refer to the Index (☞ pgs. 69 – 75) and familiarize yourself with button locations, etc. before use.
- read thoroughly the Safety Precautions and Safety Instructions that follow. They contain extremely important information regarding the safe use of this product.

You are recommended to carefully read the cautions on pages 77 through 79 before use.

SAFETY PRECAUTIONS



CAUTION

RISK OF ELECTRIC SHOCK
DO NOT OPEN



CAUTION: TO REDUCE THE RISK OF ELECTRIC SHOCK,
DO NOT REMOVE COVER (OR BACK).
NO USER-SERVICEABLE PARTS INSIDE.
REFER SERVICING TO QUALIFIED SERVICE PERSONNEL.



The lightning flash with arrowhead symbol, within an equilateral triangle, is intended to alert the user to the presence of uninsulated "dangerous voltage" within the product's enclosure that may be of sufficient magnitude to constitute a risk of electric shock to persons.



The exclamation point within an equilateral triangle is intended to alert the user to the presence of important operating and maintenance (servicing) instructions in the literature accompanying the appliance.

The AA-V40U AC Power Adapter/Charger should be used with:

AC 120 V~, 60 Hz in the USA and Canada,
AC 110 V – 240 V~, 50 Hz/60 Hz in other countries.

CAUTION (applies to the AA-V40U)

TO PREVENT ELECTRIC SHOCK MATCH WIDE BLADE OF PLUG TO WIDE SLOT, FULLY INSERT.

ATTENTION (s'applique à l'AA-V40U)

POUR ÉVITER LES CHOCS ÉLECTRIQUES, INTRODUIRE LA LAME LA PLUS LARGE DE LA FICHE DANS LA BORNE CORRESPONDANTE DE LA PRISE ET POUSSER JUSQU'AU FOND.

WARNING:

TO PREVENT FIRE OR SHOCK HAZARD, DO NOT EXPOSE THIS UNIT TO RAIN OR MOISTURE.

NOTES:

- The rating plate (serial number plate) and safety caution are on the bottom and/or the back of the main unit.
- The rating plate (serial number plate) of the AC Power Adapter/Charger is on its bottom.

This camcorder is designed to be used with NTSC-type color television signals. It cannot be used for playback with a television of a different standard. However, live recording and LCD monitor/viewfinder playback are possible anywhere. Use the BN-V408U/V416U/V428U battery packs and, to recharge them, the provided multi-voltage AC Power Adapter/Charger. (An appropriate conversion adapter may be necessary to accommodate different designs of AC outlets in different countries.)

When the equipment is installed in a cabinet or on a shelf, make sure that it has sufficient space on all sides to allow for ventilation (10 cm (3-15/16") or more on both sides, on top and at the rear).

Do not block the ventilation holes. (If the ventilation holes are blocked by a newspaper, or cloth etc. the heat may not be able to get out.)

No naked flame sources, such as lighted candles, should be placed on the apparatus.

When discarding batteries, environmental problems must be considered and the local rules or laws governing the disposal of these batteries must be followed strictly.

The apparatus shall not be exposed to dripping or splashing.

Do not use this equipment in a bathroom or places with water.

Also do not place any containers filled with water or liquids (such as cosmetics or medicines, flower vases, potted plants, cups etc.) on top of this unit. (If water or liquid is allowed to enter this equipment, fire or electric shock may be caused.)

IMPORTANT PRODUCT SAFETY INSTRUCTIONS

Electrical energy can perform many useful functions. But improper use can result in potential electrical shock or fire hazards. This product has been engineered and manufactured to assure your personal safety. In order not to defeat the built-in safeguards, observe the following basic rules for its installation, use and servicing.

ATTENTION:

Follow and obey all warnings and instructions marked on your product and its operating instructions. For your safety, please read all the safety and operating instructions before you operate this product and keep this manual for future reference.

INSTALLATION

1. Grounding or Polarization

- (A) Your product may be equipped with a polarized alternating-current line plug (a plug having one blade wider than the other). This plug will fit into the power outlet only one way. This is a safety feature. If you are unable to insert the plug fully into the outlet, try reversing the plug. If the plug should still fail to fit, contact your electrician to replace your obsolete outlet. Do not defeat the safety purpose of the polarized plug.
- (B) Your product may be equipped with a 3-wire grounding-type plug, a plug having a third (grounding) pin. This plug will only fit into a grounding-type power outlet. This is a safety feature. If you are unable to insert the plug into the outlet, contact your electrician to replace your obsolete outlet. Do not defeat the safety purpose of the grounding-type plug.

2. Power Sources

Operate your product only from the type of power source indicated on the marking label. If you are not sure of the type of power supply to your home, consult your product dealer or local power company. If your product is intended to operate from battery power, or other sources, refer to the operating instructions.

3. Overloading

Do not overload wall outlets, extension cords, or integral convenience receptacles as this can result in a risk of fire or electric shock.

4. Power Cord Protection

Power supply cords should be routed so that they are not likely to be walked on or pinched by items placed upon or against them, paying particular attention to cords at plugs, convenience receptacles, and the point where they exit from the product.

5. Ventilation

Slots and openings in the cabinet are provided for ventilation. To ensure reliable operation of the product and to protect it from overheating, these openings must not be blocked or covered.

- Do not block the openings by placing the product on a bed, sofa, rug or other similar surface.
- Do not place the product in a built-in installation such as a bookcase or rack unless proper ventilation is provided or the manufacturer's instructions have been adhered to.

6. Wall or Ceiling Mounting

The product should be mounted to a wall or ceiling only as recommended by the manufacturer.

ANTENNA INSTALLATION INSTRUCTIONS

1. Outdoor Antenna Grounding

If an outside antenna or cable system is connected to the product, be sure the antenna or cable system is grounded so as to provide some protection against voltage surges and built-up static charges. Article 810 of the National Electrical Code, ANSI/NFPA 70, provides information with regard to proper grounding of the mast and supporting structure, grounding of the lead-in wire to an antenna discharge unit, size of grounding conductors, location of antenna discharge unit, connection to grounding electrodes, and requirements for the grounding electrode.

2. Lightning

For added protection for this product during a lightning storm, or when it is left unattended and unused for long periods of time, unplug it from the wall outlet and disconnect the antenna or cable system. This will prevent damage to the product due to lightning and power-line surges.

3. Power Lines

An outside antenna system should not be located in the vicinity of overhead power lines or other electric light or power circuits, or where it can fall into such power lines or circuits. When installing an outside antenna system, extreme care should be taken to keep from touching such power lines or circuits as contact with them might be fatal.

EXAMPLE OF ANTENNA GROUNDING AS PER NATIONAL ELECTRICAL CODE, ANSI/NFPA 70

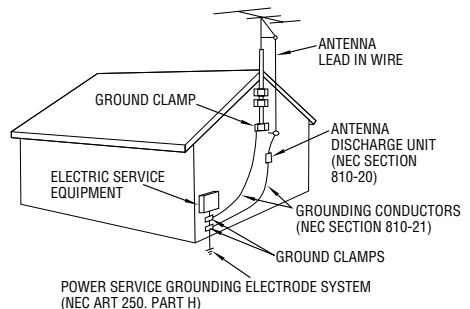

NEC - NATIONAL ELECTRICAL CODE

USE

1. Accessories

To avoid personal injury:

- Do not place this product on an unstable cart, stand, tripod, bracket or table. It may fall, causing serious injury to a child or adult, and serious damage to the product.
- Use only with a cart, stand, tripod, bracket, or table recommended by the manufacturer or sold with the product.
- Use a mounting accessory recommended by the manufacturer and follow the manufacturer's instructions for any mounting of the product.
- Do not try to roll a cart with small casters across thresholds or deep-pile carpets.

2. Product and Cart Combination

A product and cart combination should be moved with care. Quick stops, excessive force, and uneven surfaces may cause the product and cart combination to overturn.

PORTABLE CART WARNING
(Symbol provided by RETAC)



3. Water and Moisture

Do not use this product near water—for example, near a bath tub, wash bowl, kitchen sink or laundry tub, in a wet basement, or near a swimming pool and the like.

4. Object and Liquid Entry

Never push objects of any kind into this product through openings as they may touch dangerous voltage points or short-out parts that could result in a fire or electric shock. Never spill liquid of any kind on the product.

5. Attachments

Do not use attachments not recommended by the manufacturer of this product as they may cause hazards.

6. Cleaning

Unplug this product from the wall outlet before cleaning. Do not use liquid cleaners or aerosol cleaners. Use a damp cloth for cleaning.

7. Heat

The product should be situated away from heat sources such as radiators, heat registers, stoves, or other products (including amplifiers) that produce heat.

SERVICING

1. Servicing

If your product is not operating correctly or exhibits a marked change in performance and you are unable to restore normal operation by following the detailed procedure in its operating instructions, do not attempt to service it yourself as opening or removing covers may expose you to dangerous voltage or other hazards. Refer all servicing to qualified service personnel.

2. Damage Requiring Service

Unplug this product from the wall outlet and refer servicing to qualified service personnel under the following conditions:

- When the power supply cord or plug is damaged.
- If liquid has been spilled, or objects have fallen into the product.
- If the product has been exposed to rain or water.
- If the product does not operate normally by following the operating instructions. Adjust only those controls that are covered by the operating instructions as an improper adjustment of other controls may result in damage and will often require extensive work by a qualified technician to restore the product to its normal operation.
- If the product has been dropped or damaged in any way.
- When the product exhibits a distinct change in performance—this indicates a need for service.

3. Replacement Parts

When replacement parts are required, be sure the service technician has used replacement parts specified by the manufacturer or have the same characteristics as the original part. Unauthorized substitutions may result in fire, electric shock or other hazards.

4. Safety Check

Upon completion of any service or repairs to this product, ask the service technician to perform safety checks to determine that the product is in safe operating condition.

SAFETY PRECAUTIONS

Do not point the lens or the viewfinder directly into the sun. This can cause eye injuries, as well as lead to the malfunctioning of internal circuitry. There is also a risk of fire or electric shock.

CAUTION!

The following notes concern possible physical damage to the camcorder and to the user.

When carrying, be sure to always securely attach and use the provided shoulder strap. Carrying or holding the camcorder by the viewfinder and/or the LCD monitor can result in dropping the unit, or in a malfunction.

Take care not to get your finger caught in the cassette holder cover. Do not let children operate the camcorder, as they are particularly susceptible to this type of injury.

Do not use a tripod on unsteady or unlevel surfaces. It could tip over, causing serious damage to the camcorder.

CAUTION!

Connecting cables (Audio/Video, S-Video, Editing, DC, etc.) to the camcorder and leaving the unit on top of the TV is not recommended, as tripping on the cables will cause the camcorder to fall, resulting in damage.

Mini **DV** NTSC

- This camcorder is designed exclusively for the digital video cassette. Only cassettes marked "Mini **DV**" can be used with this unit.

Before recording an important scene . . .

- make sure you only use cassettes with the Mini DV mark **Mini DV**.
- remember that this camcorder is not compatible with other digital video formats.
- remember that this camcorder is intended for private consumer use only. Any commercial use without proper permission is prohibited. (Even if you record an event such as a show, performance or exhibition for personal enjoyment, it is strongly recommended that you obtain permission beforehand.)

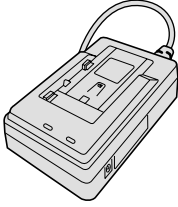

• AC Power Adapter/Charger
AA-V40U

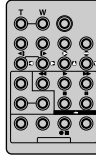

• Remote Control Unit
RM-V716U

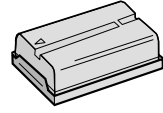

• Battery Pack BN-V408U



• AAA (R03) Battery x 2
(for remote control unit)

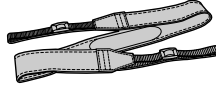

• Shoulder Strap



• Lens Cap

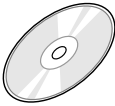

- CD-ROM
The CD ROM contains the following 7 software programs:
- JLiP Video Capture
 - JLiP Video Producer
 - Picture Navigator (for Windows®)
 - Picture Navigator (for Macintosh®)

Presto!

- Mr. Photo
- PhotoAlbum
- ImageFolio

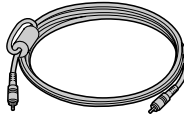

• Editing Cable

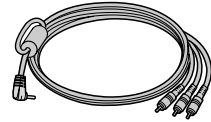

• Audio/Video Cable
(ø3.5 mini-plug to
RCA plug)

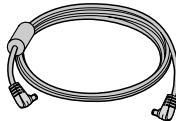

• DC Cord



• PC Connection Cable

How To Attach The Lens Cap

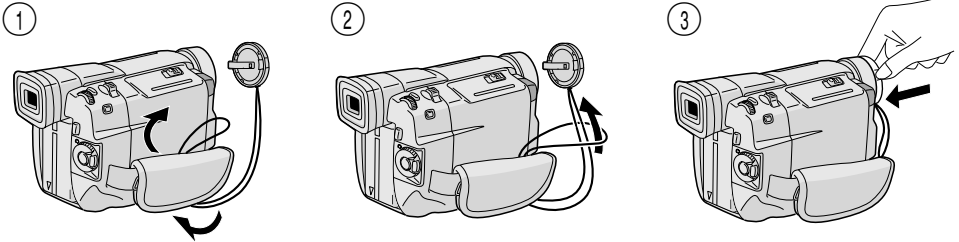

To protect the lens, attach the provided lens cap to the camcorder as shown in the illustration.

AUTOMATIC DEMONSTRATION

Automatic Demonstration takes place when “**DEMO. MODE**” is set to “**ON**” (factory-preset).

- Available when the Power Switch is set to “**A**” or “**M**” and no cassette is in the camcorder.
- Performing any operation during the demonstration stops the demonstration temporarily. If no operation is performed for more than 1 minute after that, the demonstration will resume.
- “**DEMO. MODE**” remains “**ON**” even if the camcorder power is turned off.
- To cancel Automatic Demonstration, set the Power Switch to “**M**”, then press the **MENU/BRIGHT** wheel while the demo is in progress. This takes you directly to the demo mode’s Setting Menu (so you will not have to go through the Menu Screen). Rotate the **MENU/BRIGHT** wheel to select “**OFF**” and press it. The normal screen appears.

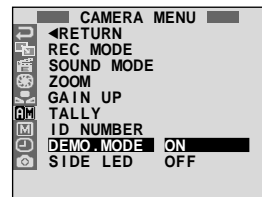
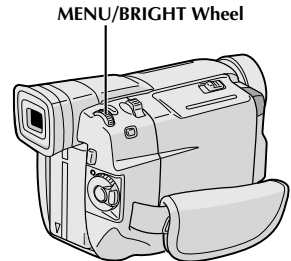

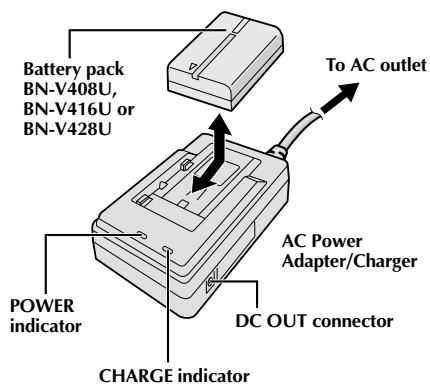

Power

This camcorder's 2-way power supply system lets you choose the most appropriate source of power. Do not use provided power supply units with other equipment.

CHARGING THE BATTERY PACK

- 1 Make sure you unplug the camcorder's DC cord from the AC Power Adapter/Charger. Plug the AC Adapter/Charger's power cord into an AC outlet. The POWER indicator lights.
- 2 Attach the battery pack with the \oplus \ominus mark aligned with the corresponding marks on the AC Power Adapter/Charger. The CHARGE Indicator begins blinking to indicate charging has started.
- 3 When the CHARGE indicator stops blinking but stays lit, charging is finished. Slide the battery and lift off. Remember to unplug the AC Adapter/Charger's power cord from the AC outlet.

Battery pack	Fully charging time
BN-V408U	approx. 1 hr. 30 min.
BN-V416U (optional)	approx. 2 hrs.
BN-V428U (optional)	approx. 3 hrs. 20 min.

NOTES:

- If the protective cap is attached to the battery pack, remove it first.
- Perform charging where the temperature is between 10°C and 35°C (50°F and 95°F). 20°C to 25°C (68°F to 77°F) is the ideal temperature range for charging. If the environment is too cold, charging may be incomplete.
- Charging times noted above are for a fully discharged battery pack.
- Charging time varies according to the ambient temperature and the status of the battery pack.
- To avoid interference with reception, do not use the AC Power Adapter/Charger near a radio.
- If you connect the camcorder's DC cord to the adapter during battery charging, power is supplied to the camcorder and charging stops.
- Since the AC Power Adapter/Charger processes electricity internally, it becomes warm during use. Be sure to use it only in well-ventilated areas.
- When charging the battery pack for the first time or after a long storage period, the CHARGE indicator may not light. In this case, remove the battery pack from the AC Power Adapter/Charger, then try charging again.
- If the battery operation time remains extremely short even after having been fully charged, the battery is worn out and needs to be replaced. Please purchase a new one.

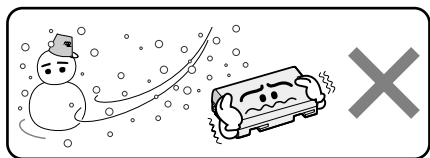

Lithium-ion is vulnerable in colder temperatures.

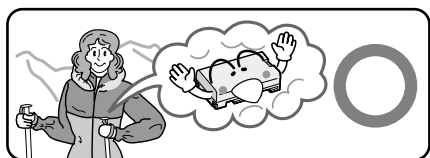

About Batteries

DANGER! Do not attempt to take the batteries apart, or expose them to flame or excessive heat, as it may cause a fire or explosion.

WARNING! Do not allow the battery or its terminals to come in contact with metals, as this can result in a short circuit and possibly start a fire.

The Benefits Of Lithium-Ion Batteries

Lithium-ion battery packs are small but have a large power capacity. However, when one is exposed to cold temperatures (below 10°C/50°F), its usage time becomes shorter and it may cease to function. If this happens, place the battery pack in your pocket or other warm, protected place for a short time, then re-attach it to the camcorder. As long as the battery pack itself is not cold, it should not affect performance.

(If you're using a heating pad, make sure the battery pack does not come in direct contact with it.)

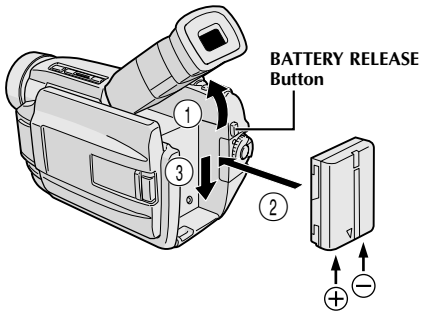
**ATTENTION:**

Before detaching the power source, make sure that the camcorder's power is turned off. Failure to do so can result in a camcorder malfunction.

INFORMATION:

VU-V856KIT is a set composed of the BN-V856U battery pack and AA-V80U AC Power Adapter/Charger. Read the VU-V856KIT's instruction manuals before using. It is impossible to charge the BN-V856U battery pack using the provided AC Power Adapter/Charger. Use the optional AA-V80U AC Power Adapter/Charger.

USING AC POWER

Use the AC Power Adapter/Charger (connect as shown in the illustration).

NOTES:

- The provided AC Power Adapter/Charger features automatic voltage selection in the AC range from 110 V to 240 V.
- For other notes, see pg. 8.

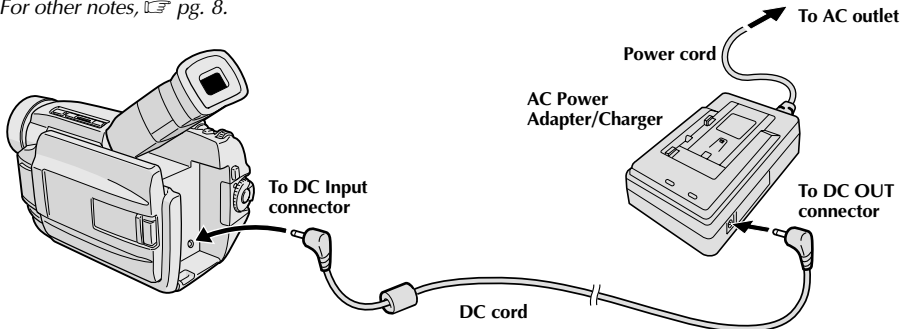
**USING THE BATTERY PACK**

1 Tilt the viewfinder upward ①.

2 With the arrow on the battery pack pointing downward, push the battery pack slightly against the battery pack mount ②, then slide down the battery pack until it locks in place ③.

- If the battery pack is attached with its ⊕ ⊖ mark set in the wrong direction, a malfunction may occur.

To Detach The Battery Pack. . .

.... tilt the viewfinder upward ① and slide the battery pack up slightly while pressing **BATTERY RELEASE** to detach it.

Approximate recording time

Battery pack	LCD monitor on/ Viewfinder off	LCD monitor off/ Viewfinder on
BN-V408U	1 hr. (35 min.)	1 hr. 15 min. (40 min.)
BN-V416U (optional)	2 hrs. (1hr. 10 min.)	2 hrs. 30 min. (1 hr. 20 min.)
BN-V428U (optional)	3 hrs. 30 min. (2 hrs.)	4 hrs. 20 min. (2 hrs. 20 min.)
BN-V856U (optional)	7 hrs. (4 hrs.)	8 hrs. 40 min. (4 hrs. 40 min.)

() : when the video light is on.

NOTES:

- Recording time is reduced significantly under the following conditions:
 - Zoom or Record-Standby mode is engaged repeatedly.
 - The LCD monitor is used repeatedly.
 - The playback mode is engaged repeatedly.
- Before extended use, it is recommended that you prepare enough battery packs to cover 3 times the planned shooting time.

Grip Adjustment

- 1 Separate the Velcro strip.
- 2 Pass your right hand through the loop and grasp the grip.
- 3 Adjust so that your thumb and fingers can easily operate the Recording Start/Stop Button and Power Zoom Lever. Refasten the Velcro strip.

Viewfinder Adjustment

- 1 Set the Power Switch to "A" or "M" while pressing down the Lock Button located on the switch.
- 2 Turn the Diopter Adjustment Control until the indications in the viewfinder are clearly focused.

Shoulder Strap Attachment

- 1 Make sure the battery pack or DC cord is removed. Following the illustration, thread the strap through the eyelet ①, then fold it back and thread it through the buckle ②. Repeat the procedure to attach the other end of the strap to the other eyelet ③ located under the Grip Strap, making sure the strap is not twisted.

Tripod Mounting

- 1 Align the screw and camera direction stud on the tripod with the camera's mounting socket and stud hole. Then tighten the screw.
 - Some tripods are not equipped with studs.

CAUTION:

When using a tripod, be sure to open and extend its legs fully to stabilize the camcorder. To prevent damage to the unit caused by falling over, do not use a small-sized tripod.

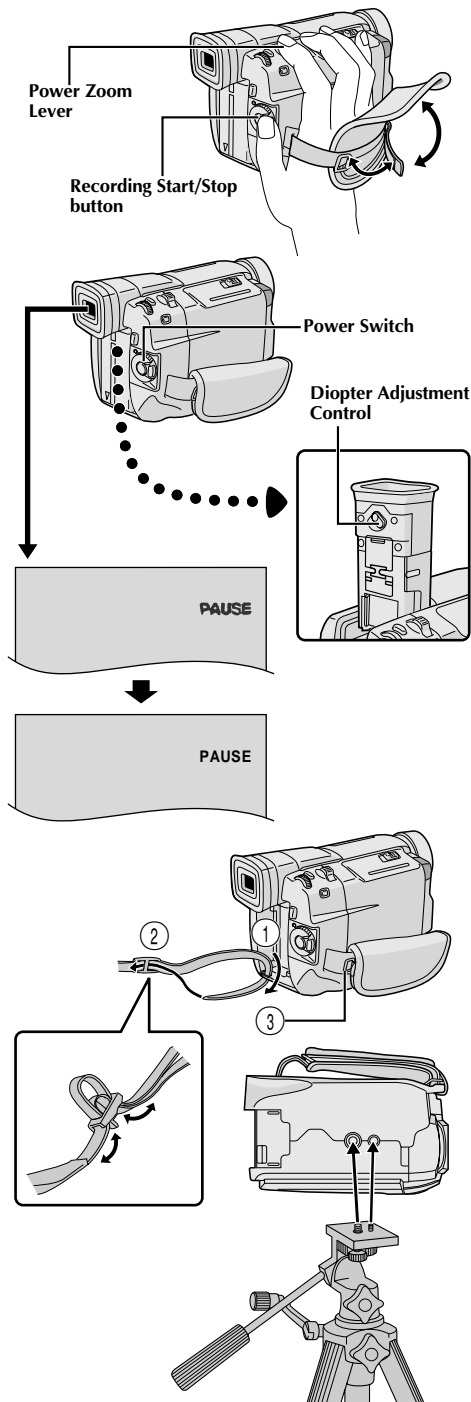

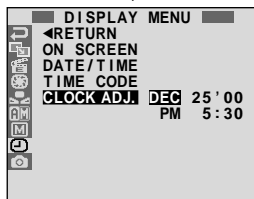
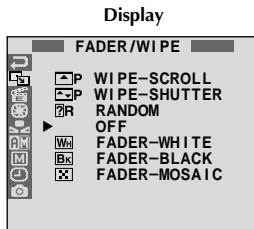
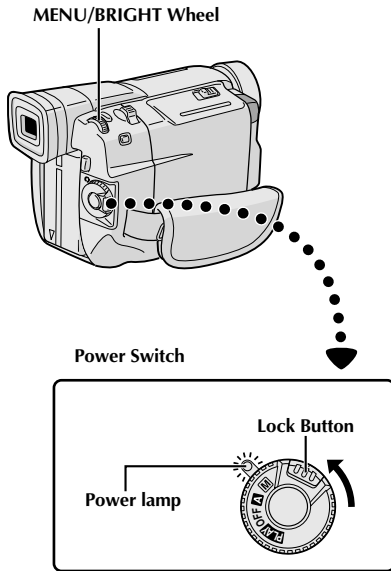

Date/Time Settings

The date/time is recorded onto the tape at all times, but its display can be turned on or off during playback (see pg. 34).

- 1 Set the Power Switch to "M" while pressing down the Lock Button located on the switch. The power lamp lights and the camcorder is turned on.
- 2 Press the MENU/BRIGHT wheel. The Menu Screen appears.
- 3 Rotate the MENU/BRIGHT wheel to select "CLOCK ADJ.". Press it and "DISPLAY MENU" appears.
- 4 Rotate the MENU/BRIGHT wheel to select "CLOCK ADJ.". Press it and "month" is highlighted. Rotate the MENU/BRIGHT wheel to input the month. Press it. Repeat to input the day, year, hour and minute. Rotate the MENU/BRIGHT wheel to select "RETURN", and press it twice. The Menu Screen closes.

NOTE:

Even if you select "CLOCK ADJ.", if the parameter is not highlighted the camcorder's internal clock continues to operate. Once you move the highlight bar to the first date/time parameter (month), the clock stops. When you finish setting the minute and press the MENU/BRIGHT wheel, the date and time begin operation from the date and time you just set.

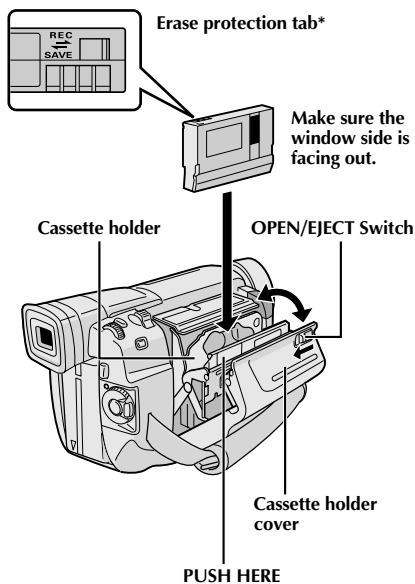

Loading/Unloading A Cassette

The camcorder needs to be powered up to load or eject a cassette.

- 1** Slide and hold **OPEN/EJECT** in the direction of the arrow then pull the cassette holder cover open until it locks. The cassette holder opens automatically.
 - Do not touch internal components.
- 2** Insert or remove a tape and press "PUSH HERE" to close the cassette holder.
 - Once the cassette holder is closed, it recedes automatically. Wait until it recedes completely before closing the cassette holder cover.
 - When the battery's charge is low, you may not be able to close the cassette holder cover. Do not apply force. Replace the battery with a fully charged one before continuing.
- 3** Close the cassette holder cover firmly until it locks into place.

Approximate recording time

Tape	Recording mode	
	SP	LP
30 min.	30 min.	45 min.
60 min.	60 min.	90 min.
80 min.	80 min.	120 min.

* To Protect Valuable Recordings . . .

... slide the erase protection tab on the back of the tape in the direction of "SAVE". This prevents the tape from being recorded over. To record on this tape, slide the tab back to "REC" before loading it.

NOTES:

- It takes a few seconds for the cassette holder to open. Do not apply force.
- If you wait a few seconds and the cassette holder does not open, close the cassette holder cover and try again. If the cassette holder still does not open, turn the camcorder off then on again.
- If the tape does not load properly, open the cassette holder cover fully and remove the cassette. A few minutes later, insert it again.
- When the camcorder is suddenly moved from a cold place to a warm environment, wait a short time before opening the cassette holder cover.
- Closing the cassette holder cover before the cassette holder comes out may cause damage to the camcorder.
- Even when the camcorder is switched off, a cassette can be loaded or unloaded. After the cassette holder is closed with the camcorder switched off, however, it may not recede. It is recommended to turn the power on before loading or unloading.
- When resuming recording, once you open the cassette holder cover a blank portion will be recorded on the tape or a previously recorded scene will be erased (recorded over) regardless of whether the cassette holder came out or not. See page 21 for information about recording from the middle of a tape.
- Loosen the Grip Strap if it appears to interfere with the cassette holder cover operation (☞ pg. 10).

Recording Mode Setting

Set the tape recording mode depending on your preference.

- 1** Set the Power Switch to “- Audio Dubbing ( pg. 60) and Insert Editing ( pg. 61) are impossible on a tape recorded in the LP mode.
- “LP” (Long Play) is more economical, providing 1.5 times the recording time.

NOTES:

- If the recording mode is switched during recording, the playback picture will be blurred at the switching point.
- It is recommended that tapes recorded in the LP mode on this camcorder be played back on this camcorder.
- During playback of a tape recorded on another camcorder, blocks of noise may appear or there may be momentary pauses in the sound.

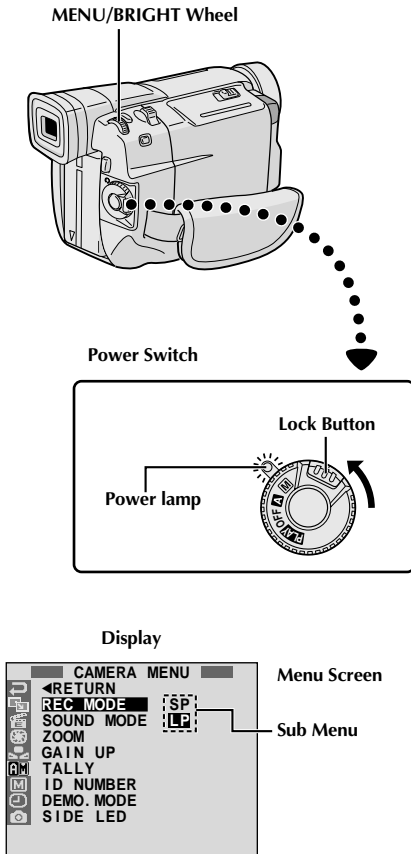

MENU/BRIGHT Wheel

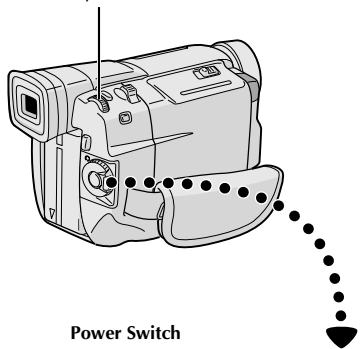

Power Switch

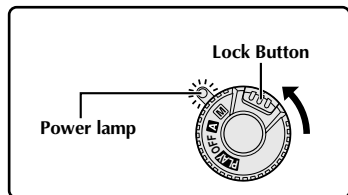

Display

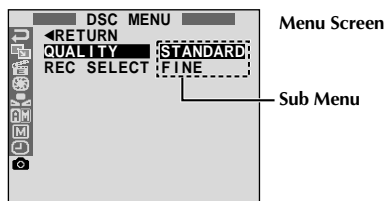

Picture Quality Mode Setting

The Picture Quality mode can be selected to best match your needs. Two Picture Quality modes are available: FINE and STANDARD (in order of quality).

- 1** Set the Power Switch to "M" while pressing down the Lock Button located on the switch. The power lamp lights and the camcorder is turned on.
- 2** Press the MENU/BRIGHT wheel. The Menu Screen appears.
- 3** Rotate the MENU/BRIGHT wheel to select "QUALITY" and press it. "DSC MENU" appears.
- 4** Rotate the MENU/BRIGHT wheel to select "QUALITY" and press it. The Sub Menu appears. Rotate the MENU/BRIGHT wheel to select the desired mode and press it. Rotate the MENU/BRIGHT wheel to select "◀RETURN", and press it twice. The Menu Screen closes.

Picture Quality Mode	Approximate Number of Storable Images
FINE	30
STANDARD	60

NOTES:

- The number of storable images depends on the selected Picture Quality mode as well as the composition of the subjects in the images.
- The numbers listed above are applicable when the camcorder's memory is empty (when there are no sample images stored).

To turn on the camcorder, set the Power Switch to any operation mode except "OFF" while pressing down the Lock Button located on the switch.

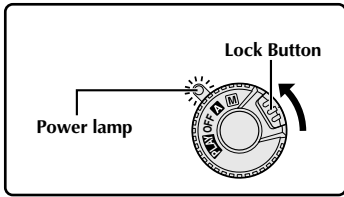
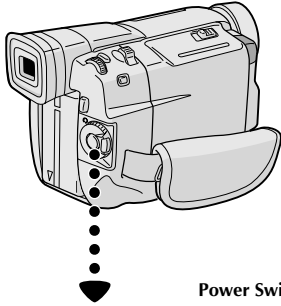

When the Power Switch is set to "A", "F. AUTO" appears. When set to "M" or "PLAY", there is no indication.

F. AUTO

When the Power Switch is set to "A" or "M" and the VIDEO/DSC Switch is set to "DSC", "DSC" appears. When set to "VIDEO", there is no indication.

DSC

Operation Mode

Choose the appropriate operation mode according to your preference using the Power Switch and VIDEO/DSC Switch.

Power Switch Position	
M (Manual):	Allows you to set various recording functions using the Menu. If you want more creative capabilities than Full Auto recording, try this mode.
A (Full Auto):	Allows you to record using NO special effects or manual adjustments. Suitable for standard recording.
OFF:	Allows you to switch off the camcorder.
PLAY :	Allows you to play back a recording on the tape, to display a still image stored in the camcorder's built-in memory or to transfer a still image recorded on the tape or in the camcorder's built-in memory to a computer.

VIDEO/DSC Switch Position	
VIDEO:	Allows you to record on a tape or play back a tape. If "REC SELECT" is set to "→ [VIDEO] → [DSC]" in the DSC Menu Screen, still images are also recorded in the camcorder's built-in memory.
DSC :	Allows you to record a still image or display a still image stored in the camcorder's built-in memory.

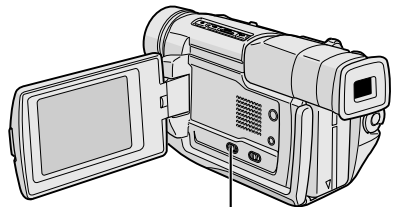

VIDEO/DSC Switch (Open the LCD monitor to access this switch.)

Power Switch

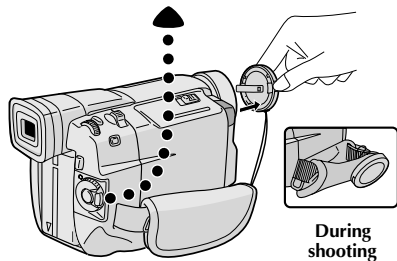
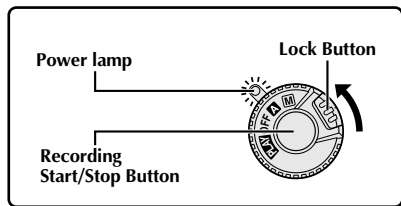

Display

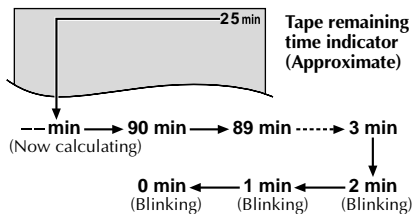

Tally lamp
(lights while recording
is in progress)

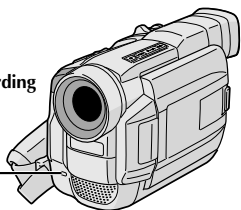
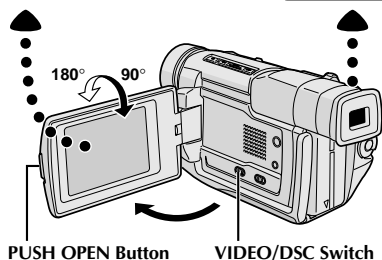
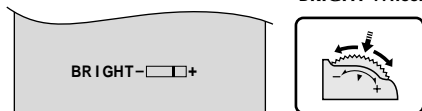
MENU/
BRIGHT Wheel**NOTE:**

You should already have performed the procedures listed below. If not, do so before continuing.

- Power (☞ pg. 8)
- Grip Adjustment (☞ pg. 10)
- Viewfinder Adjustment (☞ pg. 10)
- Load A Cassette (☞ pg. 12)
- Recording Mode Setting (☞ pg. 13)

1 Press in the tabs on the lens cap to remove it. Press **PUSH OPEN**, open the LCD monitor and set the **VIDEO/DSC** Switch to "VIDEO".

2 Set the Power Switch to "A" or "M" while pressing down the Lock Button located on the switch.

Shooting while using the LCD monitor: Make sure the LCD monitor is fully open. Tilt it upward/downward for best viewability.

Shooting while using the viewfinder: Close the LCD monitor.

- The power lamp lights and the camcorder enters the Record-Standby mode. "PAUSE" is displayed.

3 Press the Recording Start/Stop Button. "REC" appears while recording is in progress.

To Stop Recording . . .

.... press the Recording Start/Stop Button. The camcorder re-enters the Record-Standby mode.

To Adjust The Brightness Of The Display

.... rotate the **MENU/BRIGHT** wheel until the bright level indicator on the display moves and the appropriate brightness is reached.

- If you are using the GR-DVL805, it is also possible to adjust the brightness of the viewfinder by closing the LCD monitor and adjusting as described above.

NOTES:

- When you use the LCD monitor outdoors in direct sunlight, the LCD monitor may be difficult to see. If this happens, use the viewfinder instead.
- The image will not appear simultaneously in the LCD monitor and the viewfinder .
- The cassette holder cannot be opened unless a power supply is attached.
- There may be a delay after you open the cassette holder cover until the cassette holder opens. Do not use force.
- Once the cassette holder is closed, it recedes automatically. Wait until it recedes completely before closing the cassette holder cover.
- The time required to calculate and display the remaining tape length, and the accuracy of the calculation, may vary according to the type of tape used.
- "TAPE END" appears when the tape reaches its end, and the power goes off automatically if left in this condition for 5 minutes. "TAPE END" also appears when a cassette at its end is loaded.
- If the Record-Standby mode continues for 5 minutes, the camcorder's power shuts off automatically. To turn the camcorder on again, set the Power Switch to "OFF", then back to "A" or "M".
- When a blank portion is left between recorded scenes on the tape, the time code is interrupted and errors may occur when editing the tape. To avoid this, refer to "Recording from the middle of a tape" (pg. 21).
- During recording, sound is not heard from the speaker.
- To turn the tally lamp off during recording, pg. 24, 25.
- To remove the indications from the camcorder's display during recording, pg. 24, 27.

**JOURNALISTIC SHOOTING**

In some situations, different shooting angles may provide more dramatic results. Hold the camcorder in the desired position and tilt the LCD monitor in the most convenient direction. It can rotate 270° (90° downward, 180° upward).

SELF-RECORDING

You can shoot yourself while viewing your own image in the LCD monitor. Open the LCD monitor and tilt it upward 180° so that it faces forward, then point the lens toward yourself and start recording.

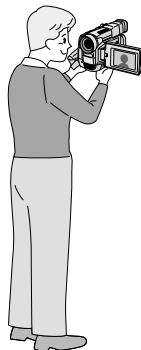
**Self-Recording**

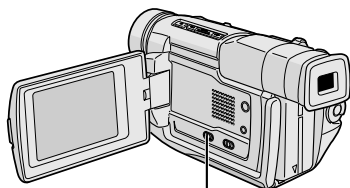
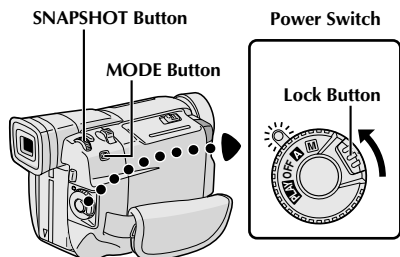

VIDEO/DSC Switch (Open the LCD monitor to access this switch.)

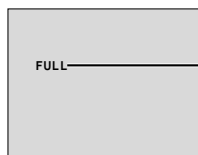

FULL Snapshot mode



FRAME
Snapshot mode with
frame*



MULTI-9
Multi-Analyzer 9

FULL
Snapshot mode with no
frame*

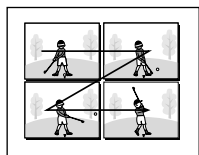

MULTI-4
Multi-Analyzer 4



PIN-UP
Pin-Up mode*

Snapshot (For Video Recording)

This feature lets you record still images that look like photographs onto a tape.

SNAPSHOT MODE SELECTION

- 1 Set the **VIDEO/DSC** Switch to "VIDEO", then set the Power Switch to "A" or "M" while pressing down the Lock Button located on the switch.
- 2 Choose the appropriate Snapshot mode from the 5 available by repeatedly pressing **MODE** until the desired snapshot mode indicator appears.

SNAPSHOT RECORDING

- 1 Press **SNAPSHOT**.
If you press during Record-Standby . . .
 "PHOTO" appears and a still image will be recorded for approx. 6 seconds, then the camcorder re-enters the Record-Standby mode.
If you press during Recording . . .
 "PHOTO" appears and a still image will be recorded for approx. 6 seconds, then the normal recording resumes.

Motor Drive Mode

Keeping **SNAPSHOT** pressed provides an effect similar to serial photography. (Interval between still images: approx. 1 second)

NOTES:

- Even if "MULTI-4" or "MULTI-9" is engaged, Snapshot recording will be performed in the FULL mode during Digital Zoom.
- If Snapshot recording is not possible, "PHOTO" blinks when **SNAPSHOT** is pressed.
- If Program AE with special effects (☞ pg. 30) is engaged, certain modes of Program AE with special effects are disabled during Snapshot recording. In such a case, the icon blinks.
- If **SNAPSHOT** is pressed when "DIS" is set to "ON" (☞ pg. 26), the Stabilizer will be disabled.
- When "REC SELECT" is set to "☞ [RECORD] ☞ [M] " in the Menu Screen (☞ pg. 27), still images are recorded not only onto the tape but also in the camcorder's built-in memory. If **SNAPSHOT** is pressed when a tape is not loaded, still images will not be recorded in the memory.
- To dub images recorded on a tape to the camcorder's built-in memory, ☞ pg. 49.
- During tape playback as well, all snapshot modes are available when "☞ [COPY] ☞ [M] COPY" is set to "OFF" in the Menu Screen (☞ pg. 34). However, the shutter sound is not heard.
- During Snapshot recording, the image displayed in the viewfinder may be partially missing. However, there is no effect in the recorded image.
- When a cable is connected to the AV connector, the shutter sound is not heard from the speaker, however it is recorded onto the tape.
- **REC** will appear while the snapshot is being taken.

* There is the sound effect of a shutter closing.

Basic Shooting (Snapshot)

You can use your camcorder as a Digital Still Camera for taking snapshots.

NOTE:

You should already have performed the procedures listed below. If not, do so before continuing.

- Power (☞ pg. 8)
- Grip Adjustment (☞ pg. 10)
- Viewfinder Adjustment (☞ pg. 10)
- Picture Quality Mode Setting (☞ pg. 14)

SNAPSHOT MODE SELECTION

- 1 Set the **VIDEO/DSC** Switch to “**DSC**”, then set the Power Switch to “**A**” or “**M**” while pressing down the Lock Button located on the switch.
- 2 Choose the appropriate Snapshot mode from the 5 available by repeatedly pressing **MODE** until the desired snapshot mode indicator appears.
 - The available Snapshot modes are the same as those on pg. 18.

SNAPSHOT RECORDING

- 1 Press **SNAPSHOT**.
The image is stored in the camcorder’s built-in memory.

To Delete Unwanted Still Images . . .

.... when unwanted still images are stored in the camcorder’s built-in memory or its memory is full, refer to “Deleting Images” (☞ pg. 40) and delete unwanted still images.

NOTES:

- Even if “**MULTI-4**” or “**MULTI-9**” is engaged, Snapshot recording will be performed in the **FULL** mode during Digital Zoom.
- Even if “**DIS**” is set to “**ON**” (☞ pg. 26), the Stabilizer will be disabled.
- If Snapshot recording is not possible, “**PHOTO**” blinks when **SNAPSHOT** is pressed.
- The Motor Drive mode (☞ pg. 18) is disabled when the **VIDEO/DSC** Switch is set to “**DSC**”.
- If Program AE with special effects (☞ pg. 30) is engaged, certain modes of Program AE with special effects are disabled during Snapshot recording. In such a case, the icon blinks.
- If shooting is not performed for approx. 5 minutes when the Power Switch is set to “**A**” or “**M**” and power is supplied from the battery pack, the camcorder shuts off automatically to save power. To perform shooting again, set the Power Switch to “**OFF**”, then to “**A**” or “**M**”.
- Some sample images have been stored in the built-in memory at the factory. If you wish to delete them, first remove the “Protect” function (☞ pg. 39), then perform the “Delete” function (☞ pg. 40).

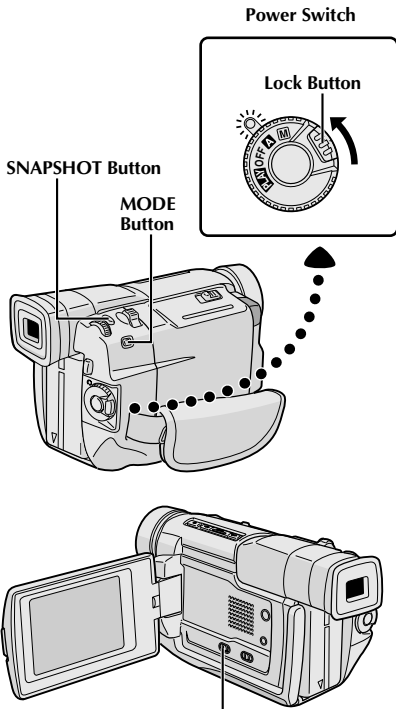

VIDEO/DSC Switch (Open the LCD monitor to access this switch.)

Total number of shots

Displays the approximate total number of shots that can be stored, including those already taken. The number increases or decreases depending on the shots stored, the Picture Quality mode, etc.

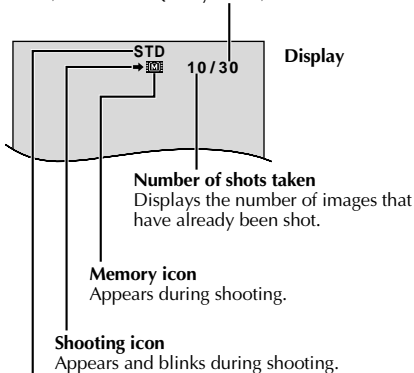

Picture Quality mode

Displays the Picture Quality mode of the stored image. There are 2 modes available: FINE and STD (Standard) (☞ pg. 14).

Zoom in (T: Telephoto)

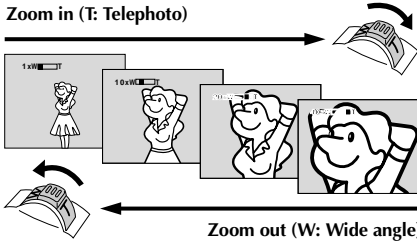

Zoom display

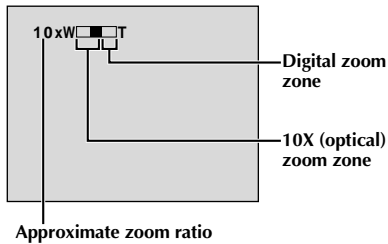

Power Zoom Lever

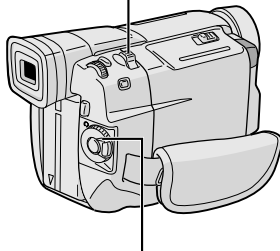

Power Switch

FEATURE: Zooming**PURPOSE:**

To produce the zoom in/out effect, or an instantaneous change in image magnification.

OPERATION:**Zoom In**

Slide the Power Zoom Lever towards "T".

Zoom Out

Slide the Power Zoom Lever towards "W".

- The further you slide the Power Zoom Lever, the quicker the zoom action.

NOTES:

- Focusing may become unstable during Zooming. In this case, set the zoom while in Record-Standby, lock the focus by using the manual focus (☞ pg. 23), then zoom in or out in Record mode.
- Zooming is possible to a maximum of 250X, or it can be switched to 10X magnification using the optical zoom (☞ pg. 25).
- Zoom magnification of over 10X is done through Digital image processing, and is therefore called Digital Zoom.
- During Digital zoom, the quality of image may suffer.
- Digital zoom cannot be used when digital image processing, such as Picture Wipe/Dissolve (☞ pg. 28, 29) or Video Echo (☞ pg. 30), is activated.
- Macro shooting (as close as approx. 5 cm (2") to the subject) is possible when the Power Zoom Lever is set all the way to "W". Also see "TELE MACRO" in the Menu Screen on page 26.

NOTE: Recording From The Middle Of A Tape

Time Code

During recording, a time code is recorded on the tape. This code is to confirm the location of the recorded scene on the tape during playback.

If recording starts from a blank portion, the time code begins counting from "00:00:00" (minute:second:frame). If recording starts from the end of a previously recorded scene, the time code continues from the last time code number.

To perform Random Assemble Editing (☞ pg. 54 – 59), time code is necessary. If during recording a blank portion is left partway through the tape, the time code is interrupted. When recording is resumed, the time code starts counting up again from "00:00:00". This means the camcorder may record the same time codes as those existing in a previously recorded scene. To prevent this, perform "Recording From The Middle of A Tape" below in the following cases;

- When shooting again after playing back a recorded tape.
- When power shuts off during shooting.
- When a tape is removed and re-inserted during shooting.
- When shooting using a partially recorded tape.
- When shooting on a blank portion located partway through the tape.
- When shooting again after shooting a scene then opening/closing the cassette holder cover.

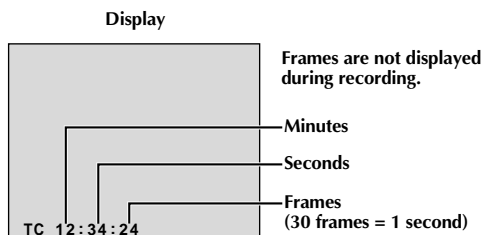

Recording From The Middle Of A Tape

1. Play back a tape to find the spot at which you want to start recording, then engage the Still Playback mode (☞ pg. 33).
2. Set the Power Switch to "A" or "M" while pressing down the Lock Button located on the switch, then start recording.

NOTES:

- The time code cannot be reset.
- During fast-forwarding and rewinding, the time code indication does not move smoothly.
- The time code is displayed only when "TIME CODE" is set to "ON" (☞ pg. 27, 34).

When a blank portion is recorded on a tape

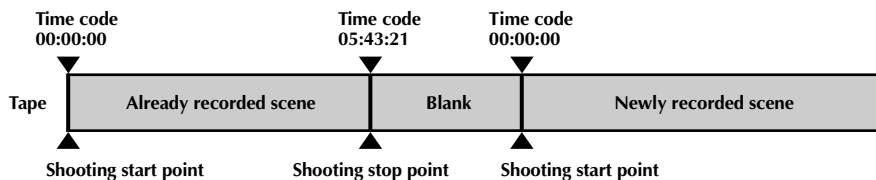

Proper recording

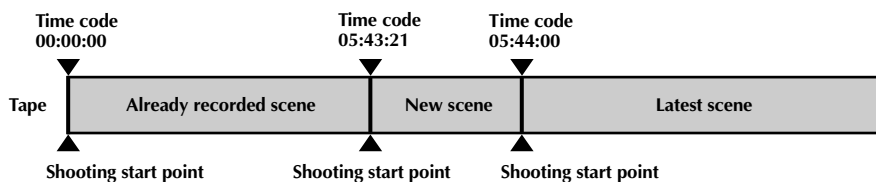

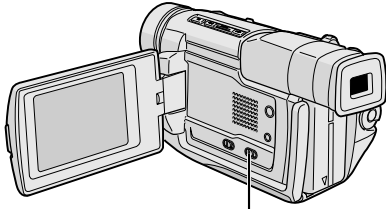

LIGHT OFF/AUTO/ON Switch
(Open the LCD monitor to
access this switch.)

DANGER

- The video light can become extremely hot. Do not touch it either while in operation or soon after turning it off, otherwise serious injury may result.
- Do not place the camcorder into the carrying case immediately after using the video light, since it remains extremely hot for some time.
- When operating, keep a distance of about 30 cm (11-13/16") between the video light and people or objects.
- Do not use near flammable or explosive materials.
- It is recommended that you consult your nearest JVC dealer for replacing the video light.



FEATURE: Video Light

PURPOSE:

To brighten the scene when natural lighting is too dim.

OPERATION:

Set **LIGHT OFF/AUTO/ON** as required:

OFF : Turns off the light.

AUTO : Automatically turns on the light when the camcorder senses insufficient lighting on the subject.

ON : Always keeps the light on as long as the camcorder is turned on.

- The video light can only be used with the camcorder's power on.
- It is recommended to set the white balance (☞ pg. 32) to ☀ when you use the video light.
- When not using the video light, turn it off to save battery power.

NOTES:

- Even if the battery indicator (☐) does not blink due to low battery charge, the camcorder may turn off automatically when you turn on the video light, or when you start recording with the video light turned on.
- When **LIGHT OFF/AUTO/ON** is set to "AUTO":
 - Depending on the lighting conditions, the video light may keep turning on and off. In this case, manually switch the light on or off using **LIGHT OFF/AUTO/ON**.
 - While the "SHUTTER" mode (☞ pg. 30) is engaged, the light is likely to stay on.
 - While the "TWILIGHT" mode (☞ pg. 30) is engaged, the light will not activate.

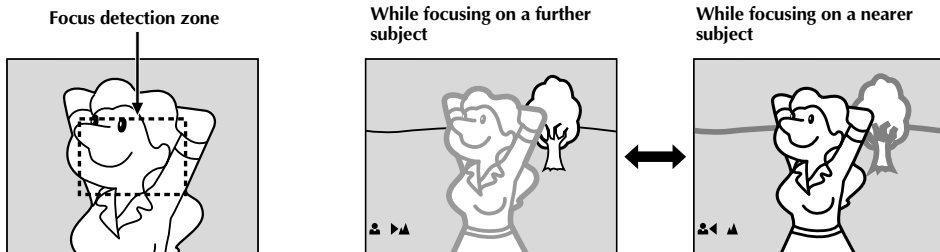

FEATURE: Auto Focus

PURPOSE:

The camcorder's Full Range AF system offers continuous shooting ability from close-up (as close as approx. 5 cm (2") to the subject) to infinity.

However, correct focus may not be obtainable in the situations listed below (in these cases use manual focusing):

- When two subjects overlap in the same scene.
- When illumination is low.*
- When the subject has no contrast (difference in brightness and darkness), such as a flat, one-color wall, or a clear, blue sky.*
- When a dark object is barely visible in the viewfinder.*
- When the scene contains minute patterns or identical patterns that are regularly repeated.
- When the scene is affected by sunbeams or light reflecting off the surface of a body of water.
- When shooting a scene with a high-contrast background.

* The following low-contrast warnings appear blinking: ▲, ◀, ▶ and 👤

NOTES:

- If the lens is smeared or blurred, accurate focusing is not possible. Keep the lens clean, wiping with a piece of soft cloth if it gets dirty. When condensation occurs, wipe with a soft cloth or wait for it to dry naturally.
- When shooting a subject close to the lens, zoom out first (☞ pg. 20). If zoomed-in in the auto focus mode, the camcorder may automatically zoom out depending on the distance between the camcorder and the subject. This will not occur when "TELE MACRO" (☞ pg. 26) is activated.

FEATURE: Manual Focus

PURPOSE:

To obtain correct focus.

OPERATION:

- 1) If you are using the viewfinder, you should already have made the necessary viewfinder adjustments (☞ pg. 10).
- 2) Set the Power Switch to "M", then press FOCUS (▶▶). The manual focus indicator appears.
- 3) To focus on a farther subject, rotate the MENU/BRIGHT wheel towards "+". "▶" appears and blinks. To focus on a nearer subject, rotate the MENU/BRIGHT wheel towards "-". "◀" appears and blinks.
- 4) Press the MENU/BRIGHT wheel. Focus adjustment is complete.

To reset to Auto Focus, press FOCUS (▶▶) twice or set the Power Switch to "A".

If FOCUS (▶▶) is pressed once, the camcorder will enter the focus adjustment mode again.

NOTES:

- Be sure to focus the lens in the maximum telephoto position when you use the Manual Focus mode. If you focus in on a subject in the wide-angle position, sharply focused images cannot be obtained when zoomed up because the depth-of-field is reduced at longer focal lengths.
- When the focus level cannot be adjusted any further or closer, "▲" or "👤" will blink.

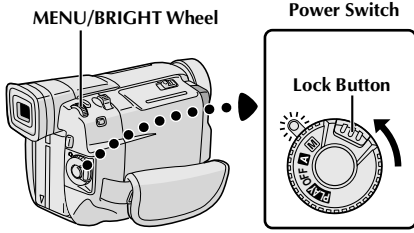





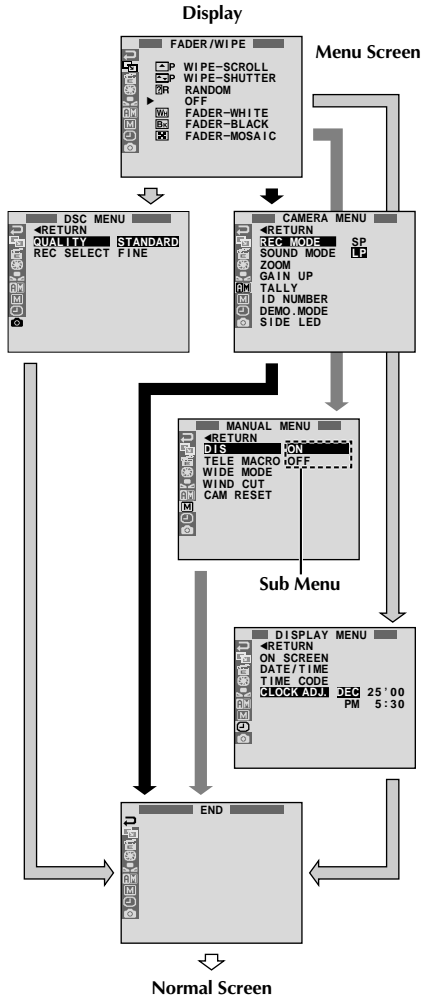

Using Menus For Detailed Adjustment

This camcorder is equipped with an easy-to-use, on-screen menu system that simplifies many of the more detailed camcorder settings (pg. 25 – 27) .







- 1 Set the Power Switch to “M” while pressing down the Lock Button located on the switch.
- 2 Press the MENU/BRIGHT wheel. The Menu Screen appears.
- 3 Rotate the MENU/BRIGHT wheel to select the desired function icon, and press it. The selected function menu appears.
- 4 Function menu setting depends on the function.
If you have selected “[Icon]”, “[Icon]”, “[Icon]” or “[Icon]” ...
 see pg. 25.
If you have selected “[Icon]”, “[Icon]”, “[Icon]” or “[Icon]” ...
 go to step 5.
- 5 Rotate the MENU/BRIGHT wheel to select the desired function and press it. The Sub Menu appears. Then, rotate the MENU/BRIGHT wheel to select the parameter, and press it. Selection is complete.
- 6 Rotate the MENU/BRIGHT wheel to select “RETURN” and press it twice. The Menu Screen closes.
 • The [Icon] icon represents “END”.

Menu Screen Explanations

	FADER/WIPE	Refer to “Fade/Wipe Effects” (☞ pg. 28, 29).	
	P.AE/EFFECT	Refer to “Program AE With Special Effects” (☞ pg. 30).	
	EXPOSURE	Refer to “Exposure Control” and “Iris Lock” (☞ pg. 31).	
	W.BALANCE	Refer to “White Balance Adjustment” and “Manual White Balance Operation” (☞ pg. 32).	
CAMERA MENU	REC MODE	Allows you to set the video recording mode (SP or LP) depending on your preference (☞ pg. 13).	
	SOUND MODE	12 BIT	Enables video recording of stereo sound on four separate channels, and is recommended for use when performing audio dubbing (☞ pg. 60). (Equivalent to the 32 kHz mode of previous models)
		16 BIT	Enables video recording of stereo sound on two separate channels. (Equivalent to the 48 kHz mode of previous models)
	ZOOM	10X	When set to “10X” while using digital zoom, the zoom magnification will reset to 10X since digital zoom will be disengaged.
		40X	Allows you to use the Digital Zoom. By digitally processing and magnifying images, zooming is possible from 10X (the optical zoom limit), to a maximum of 40X digital magnification.
		250X	Allows you to use the Digital Zoom. By digitally processing and magnifying images, zooming is possible from 10X (the optical zoom limit), to a maximum of 250X digital magnification.
	GAIN UP	OFF	Allows you to shoot dark scenes with no picture brightness adjustment.
		AGC	The overall appearance may be grainy, but the image is bright.
		AUTO 	The shutter speed is automatically adjusted (1/30 — 1/200 sec.). Shooting a subject in low or poor lighting at 1/30 sec. shutter speed provides a brighter image than in the AGC mode, but the subject’s movements are not smooth or natural. The overall appearance may be grainy. When the shutter speed is automatically adjusted, “  ” is displayed.
	TALLY	ON	The tally lamp comes on to signal the start of recording.
		OFF	The tally lamp remains off at all times.
	ID NUMBER	This number is necessary when connecting the camcorder to a device such as a computer using the J terminal (JLIP). The numbers range from 01 to 99. Factory setting is 06.	

 : Factory-preset

NOTES:

- The “ CAMERA MENU” settings are effective when the Power Switch is set to both “” and “”.
- “REC MODE” can be set when the Power Switch is set to “” or “**PLAY**” (☞ pg. 13, 34).

Menu Screen Explanations (cont.)

CAMERA MENU	DEMO. MODE	ON	Demonstrates certain functions such as Program AE with special effects, etc., and can be used to confirm how these functions operate. When "DEMO. MODE" is set to "ON" and the Menu Screen is closed, demonstration starts. Performing any operation during the demonstration stops the demonstration temporarily. If no operation is performed for more than 1 minute after that, the demonstration will resume. NOTES: <ul style="list-style-type: none"> ● If a tape is in the camcorder, the demonstration cannot be turned on. ● "DEMO. MODE" remains "ON" even if the camcorder power is turned off. ● If "DEMO. MODE" remains "ON", some functions will not be available. After viewing demo, set to "OFF".
		OFF	Automatic demonstration will not take place.
	SIDE LED	ON	The Side LED indicator (p. 74, 75) lights on the camcorder when the Power Switch is set to "A" or "M".
		OFF	
MANUAL MENU	DIS	ON	To compensate for unstable images caused by camera-shake, particularly at high magnification. NOTES: <ul style="list-style-type: none"> ● Accurate stabilization may not be possible if hand shake is excessive, or under the following conditions: <ul style="list-style-type: none"> • When shooting subjects with vertical or horizontal stripes. • When shooting dark or dim subjects. • When shooting subjects with excessive backlighting. • When shooting scenes with movement in various directions. • When shooting scenes with low-contrast backgrounds. ● Switch off this mode when recording with the camcorder on a tripod. ● The "V" indicator blinks or goes out if the Stabilizer cannot be used.
		OFF	
	TELE MACRO	ON	Usually the distance to a subject where the lens is in focus depends on the zoom magnification. Unless there is a distance more than 1m (3.3 ft.) to the subject, the lens is out of focus at the maximum telephoto setting. When set to "ON", you can shoot a subject as large as possible at a distance of approx. 60 cm (2 ft.). <ul style="list-style-type: none"> • Depending on the zoom position, the lens may go out of focus.
		OFF	
	WIDE MODE	OFF	Records with no change in the screen ratio. For playback on a TV with a normal screen ratio.
		CINEMA	Inserts black bands at the top and bottom of the screen. During playback on wide-screen TVs, the black bands at the top and bottom of the screen are cut and the screen ratio becomes 16:9. □ appears. When using this mode, refer to your wide-screen TV's instruction manual. During playback/recording on 4:3 TVs/LCD monitor/viewfinder, black bands are inserted at the top and bottom of the screen and the image appears like a letterboxed 16:9 movie. <ul style="list-style-type: none"> • The "CINEMA" mode is effective only when the VIDEO/DSC Switch is set to "VIDEO".
		SQUEEZE	For playback on TVs with an aspect ratio of 16:9. Naturally expands the image to fit the screen without distortion. ▣ appears. When using this mode, refer to your wide-screen TV's instruction manual. During playback/recording on 4:3 TVs/LCD monitor/viewfinder, the image is elongated vertically. <ul style="list-style-type: none"> • The "SQUEEZE" mode is effective only when the VIDEO/DSC Switch is set to "VIDEO".

MANUAL MENU	WIND CUT	ON	Helps cut down on noise created by wind. "🔊" appears. The quality of the sound will change. This is normal.
		OFF	Disengages the function which cuts down on noise created by wind.
	CAM RESET	CANCEL	Does not reset all settings to the factory-preset.
		EXECUTE	Resets all settings to the factory-preset.
DISPLAY MENU	ON SCREEN	LCD	Keeps the camcorder's display (except the date, time and time code) from appearing on the connected TV screen.
		LCD/TV	Makes the camcorder's display appear on screen when the camcorder is connected to a TV.
		SIMPLE	Keeps the indications (except the tape running indicator, warnings, date, time, time code, etc.) from appearing in the camcorder. Also keeps the camcorder's display (except the date, time and time code) from appearing on the connected TV screen.
	DATE/TIME	ON	The date/time is always displayed.
		OFF	The date/time does not appear.
	TIME CODE	ON	Time code is displayed on the camcorder and on the connected TV. Frame numbers are not displayed during recording.
		OFF	Time code is not displayed.
	CLOCK ADJ.	Allows you to set the current date and time (🔧 pg. 11).	
DSC MENU	QUALITY	Allows you to set the Picture Quality mode (FINE and STANDARD) depending on your preference (🔧 pg. 14).	
	REC SELECT	➔ 📷	When Snapshot recording is performed with the VIDEO/DSC Switch set to "VIDEO", still images are recorded only onto the tape.
		➔ 📷 / 📷	When Snapshot recording is performed with the VIDEO/DSC Switch set to "VIDEO", still images are recorded not only onto the tape but also in the camcorder's built-in memory.

☐ : Factory-preset

NOTES:

- The "MANUAL MENU" settings are effective only when the Power Switch is set to "📷".
- "DISPLAY MENU" functions which are set when the Power Switch is set to "📷" are also applied when the Power Switch is set to "PLAY" (🔧 pg. 34). "CLOCK ADJ." only appears when the Power Switch is set to "📷".
- The "DISPLAY MENU" settings are effective even when the Power Switch is set to "A".
- The "ON SCREEN" setting can also be changed by pressing the DISPLAY Button on the remote control (provided) (🔧 pg. 43, 46, 55).

Fade/Wipe Effects

These effects let you make pro-style scene transitions. Use them to spice up the transition from one scene to the next. You can also vary transitions from scene to scene.

IMPORTANT:

Some Fade/Wipe Effects cannot be used with certain modes of Program AE with special effects (pg. 30). If an unusable Fade/Wipe Effect is selected, its indicator blinks or goes out.

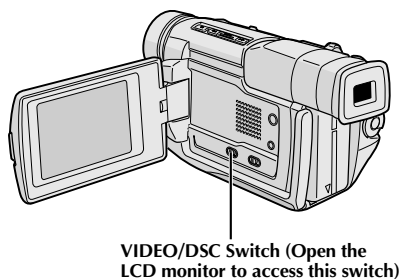
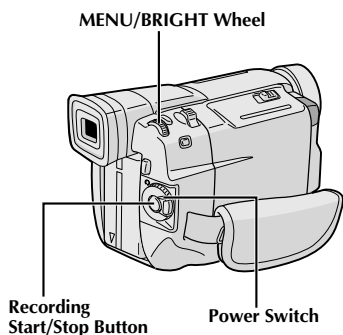

To Deactivate The Selected Effect . . .

.... select "OFF" in step 4.

NOTES:

- You can extend the length of a Fade or Wipe by pressing and holding the Recording Start/Stop Button.
- If the power is turned off after a scene is finished recording, the stored point is erased, disabling the Picture Wipe/Dissolve combination. When this happens, the Picture Wipe/Dissolve indicator blinks. Also note that power shuts off automatically if 5 minutes elapse in the Record-Standby mode.
- The sound at the end of the last recorded scene is not stored.

FADE/WIPE SELECTION (, , , , , , and)

Fade or Wipe works when video recording is started or when you stop recording.



























- 1 Set the **VIDEO/DSC** Switch to "VIDEO", then set the Power Switch to " " while pressing down the Lock Button located on the switch.
- 2 Press the **MENU/BRIGHT** wheel. The Menu Screen appears.
- 3 Rotate the **MENU/BRIGHT** wheel to select " ", then press it.
- 4 Rotate the **MENU/BRIGHT** wheel to select the desired function, then press it. Selection is complete.
 - The FADER/WIPE Menu disappears and the effect is reserved. The indicator representing the selected effect appears.
- 5 Press the Recording Start/Stop Button to activate the Fade-in/out or Wipe-in/out.

PICTURE WIPE OR DISSOLVE SELECTION (P , P , P , P , P , P and P)

The Picture Wipe or Dissolve works when video recording is started.

- 1 Follow steps 1 through 4 above.
- 2 **If you select Picture Wipe/Dissolve during recording . . .**
 - press the Recording Start/Stop Button when one scene is finished. The point at which the scene ended is stored in memory.
- If you select Picture Wipe/Dissolve during Record-Standby mode . . .**
 - press the Recording Start/Stop Button to start recording and press it again when one scene is finished. The point at which the scene ended is stored in memory.
- If you select Picture Wipe/Dissolve during Record-Standby mode after performing a Picture Wipe/Dissolve . . .**
 - the point at which the scene ended is already stored in memory.
- 3 If you start recording a new scene within 5 minutes of the end of the previous recording (without having turned the camcorder's power off), the previous scene wipes out, revealing the new scene.

Fader And Wipe Menu

Menu	Effect
 FADER — WHITE	Fade in or out with a white screen.
 FADER — BLACK	Fade in or out with a black screen.
 FADER — MOSAIC	Fade in or out with a full-screen mosaic effect.
 FADER — B.W	Fade in to a color screen from a black and white screen, or fade out from color to black and white.
 WIPE — CORNER	Wipe in on a black screen from the upper right to the lower left corner, or wipe out from lower left to upper right, leaving a black screen.
 WIPE — WINDOW	The scene starts in the center of a black screen and wipes in toward the corners, or comes in from the corners, gradually wiping out to the center.
 WIPE — SLIDE	Wipe in from right to left, or wipe out from left to right.
 WIPE — DOOR	Wipe in as the two halves of a black screen open to the left and right, revealing the scene, or wipe out and the black screen reappears from left and right to cover the scene.
 WIPE — SCROLL	The scene wipes in from the bottom to the top of a black screen, or wipes out from top to bottom, leaving a black screen.
 WIPE — SHUTTER	Wipe in from the center of a black screen toward the top and bottom, or wipe out from the top and bottom toward the center leaving a black screen.
 P DISSOLVE	The new scene gradually appears as the old one gradually disappears.
 P WIPE — CORNER	The new scene wipes in over the previous one from the upper right corner to the lower left corner.
 P WIPE — WINDOW	The next scene gradually wipes in from the center of the screen toward the corners, covering the previous scene.
 P WIPE — SLIDE	The next scene gradually wipes in over the previous one from right to left.
 P WIPE — DOOR	The previous scene wipes out from the center to the right and left, like a door being pushed open to reveal the next scene.
 P WIPE — SCROLL	The new scene wipes in over the last one from the bottom of the screen to the top.
 P WIPE — SHUTTER	The new scene wipes in over the previous one from the center toward the top and bottom of the screen.
 R RANDOM	When this function is activated, the camcorder randomly selects the effect used in scene transition (from BW ,  ,  ,  ,  ,  ,  ,  ,  , and ). The Picture Wipe/Dissolve function is not available.

IMPORTANT:

Some modes of Program AE with special effects cannot be used with certain Fade/Wipe Effects (☞ pg. 29). If an unusable mode is selected, its indicator blinks or goes out.

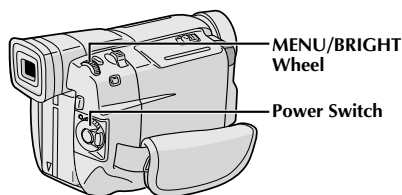

Display

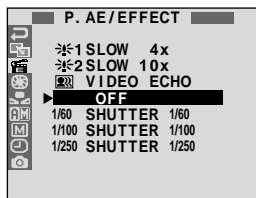

Menu Screen

Program AE With Special Effects

- 1** Set the Power Switch to "M" while pressing down the Lock Button located on the switch.
- 2** Press the MENU/BRIGHT wheel. The Menu Screen appears.
- 3** Rotate the MENU/BRIGHT wheel to select "☞", then press it.
- 4** Rotate the MENU/BRIGHT wheel to select the desired mode, then press it. Selection is complete.
 - The P.AE/EFFECT Menu disappears and the selected mode is activated. The selected mode indicator appears.

To Deactivate The Selected Mode . . .

.... select "OFF" in step 4.

NOTE:

Program AE with special effects can be changed during recording or during Record-Standby.

★ TWILIGHT

Makes evening scenes look more natural. White Balance (☞ pg. 32) is initially set to ☼, but can be changed to your desired setting. When Twilight is chosen, the camcorder automatically adjusts the focus from approx. 10 m (32 ft) to infinity. From less than 10 m (32 ft), adjust the focus manually.

SEPIA

Recorded scenes have a brownish tint like old photos. Combine this with the Cinema mode for a classic look.

B/W MONOTONE

Like classic black and white films, your footage is shot in B/W. Used together with the Cinema mode, it enhances the "classic film" effect.

CLASSIC FILM

Gives recorded scenes a strobe effect.

STROBE

Your recording looks like a series of consecutive snapshots.

VIDEO ECHO

Adds a "ghost" to the subject, giving your recording a "fantasy" feeling. Zoom magnification of over 10X is not available.

SLOW (Slow Shutter)

Lights dark subjects or areas even brighter than they would be under good natural lighting. Use "SLOW" only in dark areas.

1 SLOW 4X

The Shutter Speed is set to 1/15th of a second to quadruple the sensitivity.

2 SLOW 10X

The Shutter Speed is set to 1/6th of a second to provide 10 times the sensitivity.

NOTES:

- When using "SLOW", the image takes on a strobe-like effect.
- If the manual focus indicator blinks when "SLOW" is used, adjust focus manually and use a tripod.

SHUTTER (Variable Shutter Speed)

1/60—The shutter speed is fixed at 1/60th of a second. Black bands that usually appear when shooting a TV screen become narrower.

1/100—The shutter speed is fixed at 1/100th of a second. The flickering that occurs when shooting under a fluorescent light or mercury-vapor lamp is reduced.

1/250, 1/500—These settings allow fast-moving images to be captured one frame at a time, for vivid, stable slow-motion playback. The faster the shutter speed, the darker the picture becomes. Use the shutter function under good lighting conditions.

Exposure Control

Manual exposure adjustment is recommended in the following situations:

- When shooting using reverse lighting or when the background is too bright.
- When shooting on a reflective natural background such as at the beach or when skiing.
- When the background is overly dark or the subject light.



- 1 Set the Power Switch to “M” while pressing down the Lock Button located on the switch.
- 2 Press the MENU/BRIGHT wheel. The Menu Screen appears.
- 3 Rotate the MENU/BRIGHT wheel to select “☀”, then press it.
- 4 Rotate the MENU/BRIGHT wheel to select “MANUAL”, then press it. The Menu Screen disappears. “EXP.” and the highlight bar on the exposure control indicator are displayed.
- 5 Rotate the MENU/BRIGHT wheel towards “+” to brighten the image, or towards “-” to darken the image. (maximum ± 6)
- 6 Press the MENU/BRIGHT wheel. Exposure adjustment is complete. The indication “EXP.” and the highlight bar on the exposure control indicator go out.

To Return To Automatic Exposure Control . . .

.... select “AUTO” in step 4. Or, set the Power Switch to “A”.

NOTE:

To Brighten The Subject Quickly . . .

.... press BACKLIGHT.  is displayed and the subject is brightened. If pressed again,  disappears and the brightness returns to the previous level.

- +3 exposure has the same effect as the BACKLIGHT Button.
- Using BACKLIGHT may cause the light around the subject to become too bright and the subject to become white.
- Backlight compensation is also available when the Power Switch is set to “A”.
- Pressing the BACKLIGHT button has no effect when the exposure  is set to “MANUAL” and the Power Switch is set to “M”.

Iris Lock

Use this function in the following situations:

- When shooting a moving subject.
- When the distance to the subject changes (so its size in the LCD monitor or the viewfinder changes), such as when the subject is backing away.
- When shooting on a reflective natural background such as at the beach or when skiing.
- When shooting objects under a spotlight.
- When zooming.

When the subject is close, keep the iris locked. Even when the subject moves away from you, the image will not darken or brighten.

Before the following steps, perform steps 1 through 4 of “Exposure Control”.

- 5 Adjust zoom so that the subject fills the LCD monitor or the viewfinder, then press and hold the MENU/BRIGHT wheel for over 2 seconds. The exposure control indicator and “L” appear. Press the MENU/BRIGHT wheel. “L” changes to “” and the iris is locked. “EXP.” goes out.



Iris lock indicator

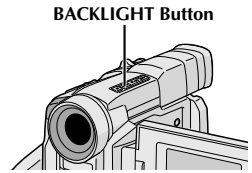

BACKLIGHT Button

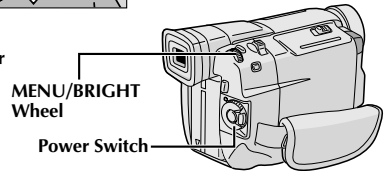

MENU/BRIGHT Wheel

Power Switch

To Return To Automatic Iris Control . . .

.... rotate the MENU/BRIGHT wheel to display “AUTO” then press it in step 4. The exposure control indicator and “L” disappears. Or, set the Power Switch to “A”.

To Lock The Exposure Control And The Iris . . .

.... after step 4, adjust the exposure rotating the MENU/BRIGHT wheel. Then lock the iris in step 5. For automatic locking, rotate the MENU/BRIGHT wheel to select “AUTO”, then press it in step 4. The iris becomes automatic after about 2 seconds.

Iris

Like the pupil of the human eye, it contracts in well-lit environments to keep too much light from entering, and dilates in dim environments to allow in more light.

White Balance Adjustment

A term that refers to the correctness of color reproduction under various lighting. If the white balance is correct, all other colors will be accurately reproduced.

The white balance is usually adjusted automatically. However, more advanced camcorder operators control this function manually to achieve a more professional color/tint reproduction.

- 1** Set the Power Switch to "M" while pressing down the Lock Button located on the switch.
- 2** Press the **MENU/BRIGHT** wheel. The Menu Screen appears.
- 3** Rotate the **MENU/BRIGHT** wheel to select "MAN.", then press it. The Menu Screen disappears and "W.BAL" and the currently selected mode are displayed.
- 4** Rotate the **MENU/BRIGHT** wheel to select the desired mode.
 - "AUTO" – White balance is adjusted automatically (factory preset).
 - "MAN." – White balance is set manually.
 - "☀" – Outdoors on a sunny day.
 - "☁" – Outdoors on a cloudy day.
 - "💡" – A video light or similar type of lighting is used.
- 5** Press the **MENU/BRIGHT** wheel. Selection is complete.

To Return To Automatic White Balance . . .

.... select "AUTO" in step 4. Or, set the Power Switch to "A".

NOTE:

White balance cannot be used when Sepia or Monotone (☞ pg. 30) is activated.

Manual White Balance Operation

Perform Manual White Balance when shooting under various types of lighting.

- 1** Follow steps 1 through 4 of the white balance adjustment, and select "MAN.".
- 2** Hold a sheet of plain white paper in front of the subject. Adjust zoom or position yourself so that the white paper fills the screen.
- 3** Press the **MENU/BRIGHT** wheel until ☑ begins blinking. When the setting is completed, ☑ stops blinking.
- 4** Press the **MENU/BRIGHT** wheel. Only the Manual White Balance indicator ☑ is displayed.

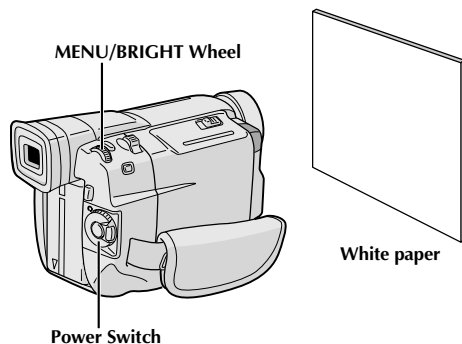

To Change The Tint For Recording . . .

.... in step 2, substitute colored paper for white.

The white balance is adjusted based on the color, changing the tint. Red paper = deeper green; blue paper = orange; yellow paper = deeper purple.

NOTES:

- In step 2, it may be difficult to focus on the white paper. In such a case, adjust focus manually (☞ pg. 23).
- A subject can be shot under various types of lighting conditions indoors (natural, fluorescent, candlelight, etc.). Because the color temperature is different depending on the light source, the subject tint will differ depending on the white balance settings. Use this function for a more natural result.
- Once you adjust white balance manually, the setting is retained even if the power is turned off or the battery removed.

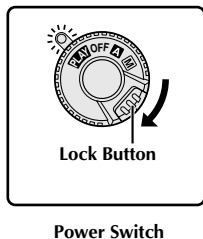
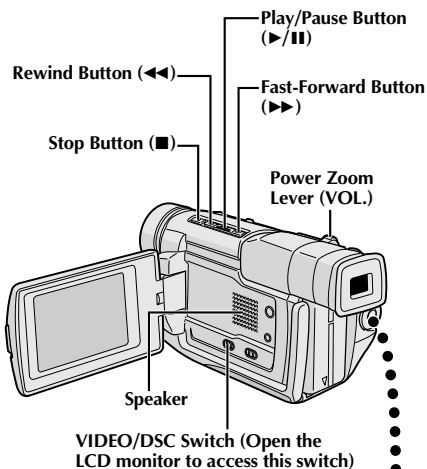

- 1** Load a tape (☞ pg. 12).
- 2** Set the **VIDEO/DSC** Switch to “VIDEO”, then set the Power Switch to “**PLAY**” while pressing down the Lock Button located on the switch. To start playback, press ▶/||.
 - To stop playback, press ■.
 - Press ◀◀ to rewind, or ▶▶ to fast-forward the tape during Stop mode.

To Control The Speaker Volume . . .

.... slide the Power Zoom Lever (VOL.) towards “+” to turn up the volume, or towards “-” to turn down the volume.

NOTES:

- If Stop mode continues for 5 minutes when power is supplied from a battery, the camcorder shuts off automatically. To turn on again, set the Power Switch to “OFF”, then to “**PLAY**”.
- The playback picture can be viewed in the LCD monitor, viewfinder or on a connected TV (☞ pg. 42).
- You can also view the playback picture on the LCD monitor with it flipped over and pushed against the camera body.
- LCD monitor/viewfinder indications:
 - When power is supplied from a battery: the “” battery pack remaining power indicator is displayed. When power is supplied through the DC cord: “” does not appear.
 - During Stop mode, none of the indications are displayed.
- When a cable is connected to the AV connector, the sound is not heard from the speaker.

Still Playback:

Pauses during playback.

- 1) Press ▶/|| during playback.
 - 2) To resume normal playback, press ▶/|| again.
- If still playback continues for more than about 3 minutes, the camcorder’s Stop mode is automatically engaged. After 5 minutes in the Stop mode, the camcorder’s power is automatically turned off.
 - When ▶/|| is pressed, the image may not pause immediately while the camcorder stabilizes the still image.

Shuttle Search:

Allows high-speed search in either direction.

- 1) Press ▶▶ for forward or ◀◀ for reverse search during playback.
 - 2) To resume normal playback, press ▶/||.
- During playback, press and hold ◀◀ or ▶▶. The search continues as long as you hold the button. Once you release it, normal playback resumes.
 - A slight mosaic effect appears on screen during Shuttle Search. This is not a malfunction.

Frame-By-Frame Playback:

Allows frame-by-frame search.

- 1) Engage Still Playback.
 - 2) Rotate the **MENU/BRIGHT** wheel towards “+” for forward Frame-By-Frame Playback, or towards “-” for reverse Frame-By-Frame Playback during Still Playback.
- To resume normal playback, press ▶/||.
 - You can also use the provided remote control for Frame-By-Frame Playback (☞ pg. 52).

Playback Zoom and Playback Special Effects

Available only with the remote control (provided) (☞ pg. 52, 53).

Using Menus For Detailed Adjustment

The following procedure applies to all except *Synchro Comp* (☞ pg. 58, 59).

- 1** Set the Power Switch to "PLAY" while pressing down the Lock Button located on the switch.
- 2** Press the MENU/BRIGHT wheel. The Menu Screen appears.
- 3** Rotate the MENU/BRIGHT wheel to select the desired function icon, and press it. The selected function menu appears.
- 4** Rotate the MENU/BRIGHT wheel to select the desired function, and press it to display the Sub Menu.
- 5** Rotate the MENU/BRIGHT wheel to select the desired parameter and press it. Selection is complete.
- 6** Rotate the MENU/BRIGHT wheel to select "◀RETURN" and press it twice to close the Menu Screen.

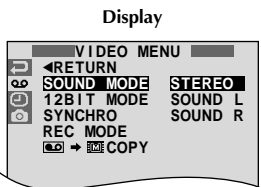
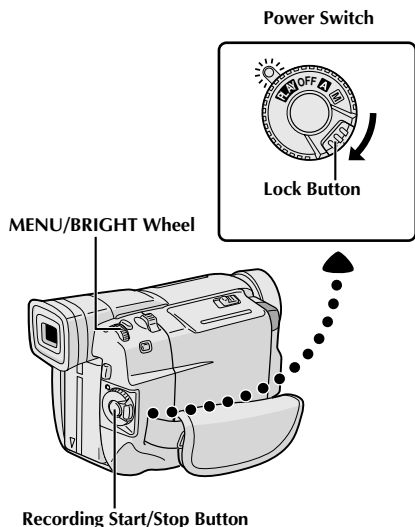

Menu Screen

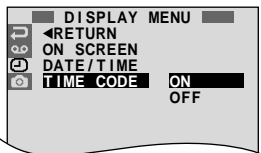

VIDEO MENU	SOUND MODE	☞ pg. 35.
	12BIT MODE	☞ pg. 35.
	SYNCHRO	☞ pg. 59.
	REC MODE	Allows you to set the video recording mode (SP or LP) depending on your preference (☞ pg. 13). It is recommended you use "REC MODE" in the "VIDEO MENU" when using this camcorder as a recorder during digital dubbing (☞ pg. 47).
	☞ → COPY	ON: Enables dubbing of images recorded on a tape to the camcorder's built-in memory (☞ pg. 49). OFF: Enables snapshots to be taken during video playback (☞ pg. 18).
DISPLAY MENU	ON SCREEN*	Makes the camcorder's indications appear/disappear from the connected TV screen.
	DATE/TIME*	Makes the date/time appear/disappear on the camcorder.
	TIME CODE*	Makes the time code appear/disappear on the camcorder.

* Each setting is linked with "DISPLAY MENU", which appears when the Power Switch is set to "M" (☞ pg. 27). The parameters are the same as in the description on pg. 27.

NOTES:

- It is also possible to change the ON SCREEN settings by pressing **DISPLAY** on the remote control (provided).
- "REC MODE" can be set when the Power Switch is set to "PLAY" or "M" (☞ pg. 13, 25).
- If "ON SCREEN" is set to "SIMPLE", it keeps the camcorder's display (except the date, time and time code) from appearing on the connected TV. It also makes the playback sound mode and tape speed disappear on the camcorder.

Playback Sound

During playback, the camcorder detects the sound mode in which the recording was made, and plays the sound back. Select the type of sound to accompany your playback picture. According to the menu access explanation on pg. 34, select "SOUND MODE" or "12BIT MODE" from the Menu Screen and set it to the desired parameter.

SOUND MODE	STEREO	Sound is output on both "L" and "R" channels in stereo.
	SOUND L	Sound from the "L" channel is output in stereo.
	SOUND R	Sound from the "R" channel is output in stereo.
12BIT MODE	SOUND 1	Original sound is output on both "L" and "R" channels in stereo.
	SOUND 2	Dubbed sound is output on both "L" and "R" channels in stereo.
	MIX	Original and dubbed sounds are combined and output in stereo on both "L" and "R" channels in stereo.

 : Factory-preset

NOTES:

- The "SOUND MODE" setting is available for both 12-bit and 16-bit sound. (In previous models' functions, "12-bit" is called "32 kHz" and "16-bit" is called "48 kHz".)
- The camcorder cannot detect the sound mode in which the recording was made during fast-forward or rewind. During playback the sound mode is displayed in the upper left corner.

Display

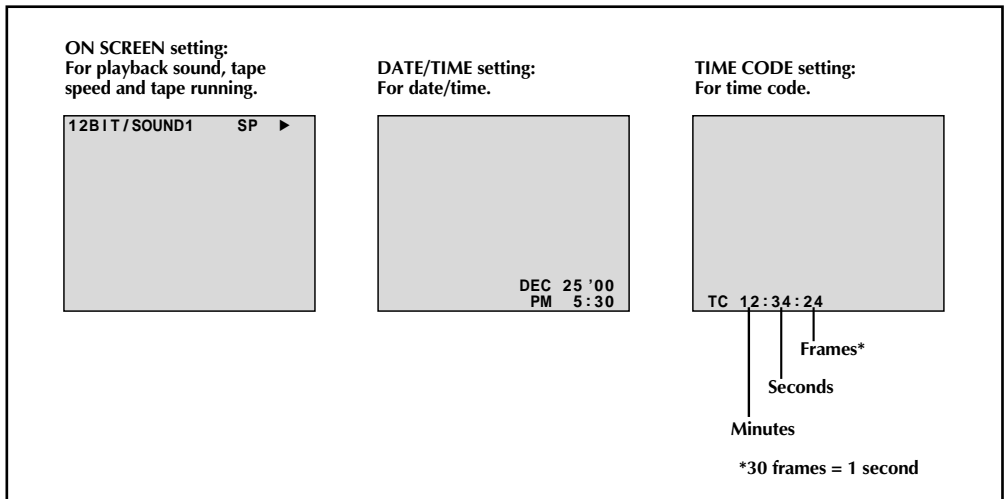

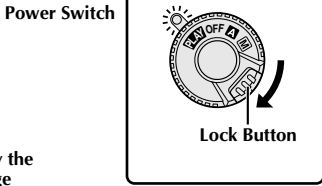
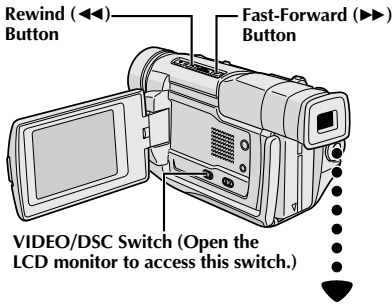

To display the next image



Display

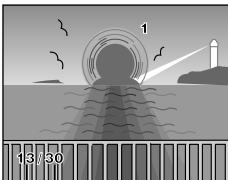
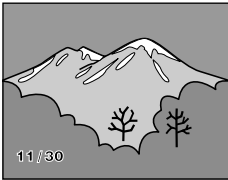
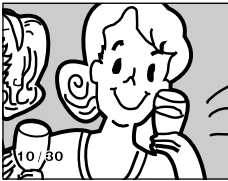

To display the previous image

Total number of images
Displays the total number of stored images.

Image number
Displays the index number of the image file (see pg. 37).

Normal Playback

Images shot with the camcorder are automatically numbered, then stored in numerical order in the camcorder's built-in memory. You can view the stored images, one at a time, much like flipping through a photo album.

- 1 Set the **VIDEO/DSC** Switch to " **DSC** ", then set the Power Switch to " **PLAY** " while pressing down the Lock Button.
 - A stored image is displayed.

- 2 Press ▶ to display the next image.
Press ◀ to display the previous image.

NOTE:

Even if you shoot a new image after playing back a low-numbered one, this will not overwrite an existing image, because new images are automatically stored after the last-recorded one.

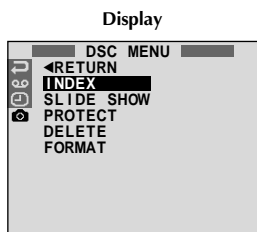
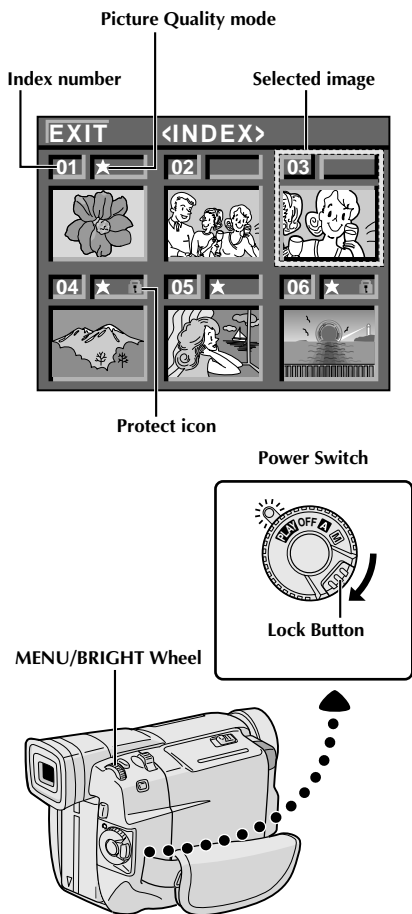

Menu Screen



Playback Screen

INDEX Screen

The images you shot can be displayed together with their index information. Convenient for checking images shot beforehand, the INDEX Screen also shows the Picture Quality mode as well as which images are protected against accidental erasure.

01: Index number

Index numbers are marked from 01. For example, when 10 images are stored (index number: 01 to 10), if three images with index numbers 02, 04 and 06 are deleted from memory, the remaining images are automatically moved up to fill any gaps in the numerical sequence. Therefore, the number of remaining images is 7, and the new index numbers range from 01 to 07.

★ : Picture Quality mode

Displays the Picture Quality mode of the stored image. There are 2 modes available: FINE and STANDARD (pg. 14). A star mark is displayed next to still images shot in the FINE mode. There are no marks next to still images shot in the STANDARD mode.

🔒 : Protect icon

When an image is protected against its accidental erasure, a padlock mark appears next to the Picture Quality mode indicator, and that image cannot be deleted.

Selected Image

An image is framed in green like this when it is selected. Rotate the **MENU/BRIGHT** wheel to move the green frame to the desired image.

Index Playback

You can view the images stored in memory six at a time. Use this mode when looking for an image you wish to view.

- 1** Perform step 1 of "Normal Playback" on pg. 36.
- 2** Press the **MENU/BRIGHT** wheel. The Menu Screen appears.
- 3** Rotate the **MENU/BRIGHT** wheel to select "🔒" and press it. "DSC MENU" appears.
- 4** Rotate the **MENU/BRIGHT** wheel to select "INDEX" and press it. The INDEX Screen appears.
- 5** Rotate the **MENU/BRIGHT** wheel to move the green frame to the desired image and press it. The selected image is displayed on the whole screen, then the screen enters normal playback.

Power Switch

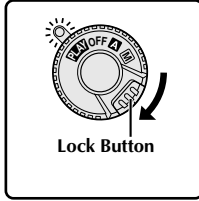

Lock Button

MENU/BRIGHT Wheel

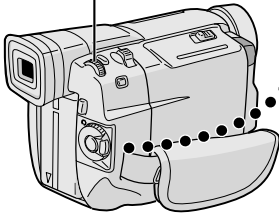

Stop (■) Button

Play/Pause (▶/⏸) Button

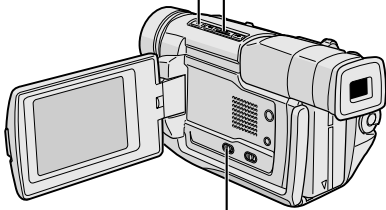

VIDEO/DSC Switch (Open the LCD monitor to access this switch.)

Display

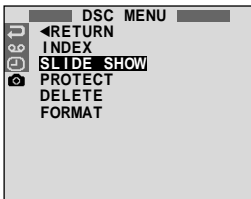

Slide Show

You can run through all the images stored in memory automatically in numerical order.

- 1** Set the VIDEO/DSC Switch to "DSC", then set the Power Switch to "PLAY", while pressing down the Lock Button.
- 2** Press the MENU/BRIGHT wheel. The Menu Screen appears.
- 3** Rotate the MENU/BRIGHT wheel to select "☑" and press it. "DSC MENU" appears.
- 4** Rotate the MENU/BRIGHT wheel to select "SLIDE SHOW" and press it. The Slide Show starts.
- 5** To stop the Slide Show, press ■.

To start the Slide Show without going through the Menu Screen . . .

.... after step 1, press ▶/⏸. To stop the Slide Show, press ■.

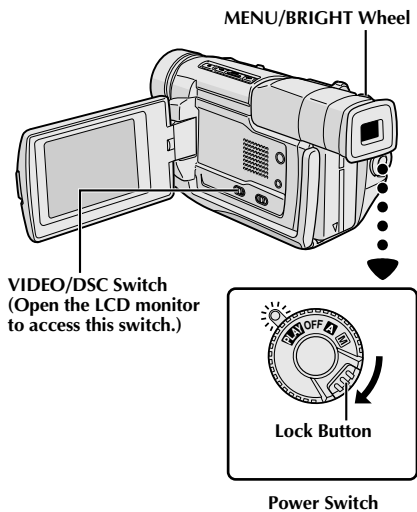

Display



Menu Screen



PROTECT Index Screen



Padlock mark

Normal playback

If Protection is removed



Normal playback

Protecting Images

The Protect mode helps prevent the accidental erasure of images. When a padlock mark is displayed next to the Picture Quality Mode indication, that image cannot be deleted.

- 1 Set the **VIDEO/DSC** Switch to "**DSC**", then set the Power Switch to "**PLAY**" while pressing down the Lock Button.
 - A stored image is displayed.
- 2 Press the **MENU/BRIGHT** wheel. The Menu Screen appears. Rotate it to select "**PROTECT**" and press it. "DSC MENU" appears.
- 3 Rotate the **MENU/BRIGHT** wheel to select "**PROTECT**" and press it. The PROTECT Index Screen appears.

TO PROTECT AN IMAGE

Before doing the following, perform steps 1 through 3 above.

- 4 Rotate the **MENU/BRIGHT** wheel to move the green frame to the desired image and press it. A "🔒" padlock mark appears on the selected image. Repeat this procedure for all images you do not wish to delete by accident.
- 5 Rotate the **MENU/BRIGHT** wheel upward to select "EXIT" and press it. The normal playback screen appears.

NOTE:

When the memory is initialized or corrupted, even protected images are deleted. If you do not want to lose important images, transfer them to a PC and save them.

TO REMOVE PROTECTION

Before doing the following, perform steps 1 through 3 above.

- 4 Rotate the **MENU/BRIGHT** wheel to move the green frame to the desired image and press it. The "🔒" padlock mark located above the image disappears and the image is no longer protected. Repeat this procedure for all images from which you wish to remove protection.
- 5 Rotate the **MENU/BRIGHT** wheel upward to select "EXIT" and press it. The normal playback screen appears.

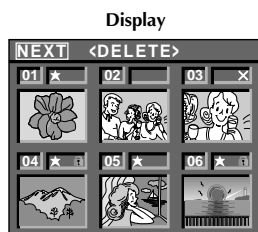
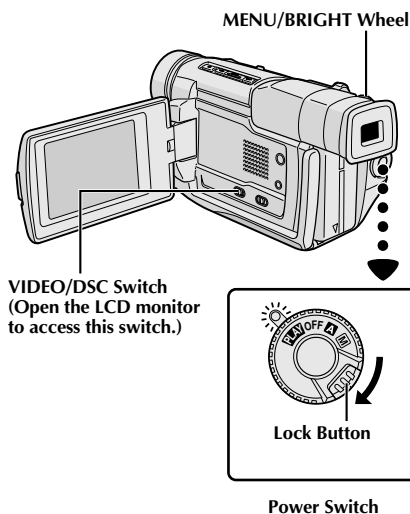

DELETED Index Screen

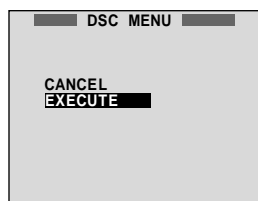

Deletion Confirmation Screen

Deleting Images

Previously shot images can be deleted either one at a time or all at once.

- 1** Set the **VIDEO/DSC** Switch to “**DSC**”, then set the Power Switch to “**PLAY**” while pressing down the Lock Button.
 - A stored image is displayed.
- 2** Press the **MENU/BRIGHT** wheel. The Menu Screen appears. Rotate it to select “**📷**” and press it. “DSC MENU” appears.
- 3** Rotate the **MENU/BRIGHT** wheel to select “**DELETE**” and press it. The Sub Menu appears.

TO SELECT AN IMAGE BY BROWSING IMAGES STORED IN MEMORY

Before doing the following, perform steps 1 through 3 above.

- 4** Rotate the **MENU/BRIGHT** wheel to select “**SELECT**” and press it. The DELETED Index Screen appears.
- 5** Rotate the **MENU/BRIGHT** wheel to move the green frame to the desired image that you wish to delete and press it. An “**✕**” appears above the selected image. Repeat this procedure for all images that you wish to delete.
 - To deselect an image, press the **MENU/BRIGHT** wheel again. The “**✕**” disappears.
- 6** Rotate the **MENU/BRIGHT** wheel upward to select “**NEXT**” and press it. The Deletion Confirmation Screen appears.
- 7** Rotate the **MENU/BRIGHT** wheel to select “**EXECUTE**” and press it. “**DELETING IN PROGRESS**” appears. The selected images are deleted and the normal playback screen appears.
 - To cancel deletion, rotate the **MENU/BRIGHT** wheel to select “**CANCEL**” and press it.

TO DELETE ALL IMAGES

Before doing the following, perform steps 1 through 3 above.

- 4** Rotate the **MENU/BRIGHT** wheel to select “**ALL**” and press it. The Deletion Confirmation Screen appears.
- 5** Rotate the **MENU/BRIGHT** wheel to select “**EXECUTE**” and press it. “**DELETING IN PROGRESS**” appears. All the images are deleted and the normal playback screen appears.
 - To cancel deletion, rotate the **MENU/BRIGHT** wheel to select “**CANCEL**” and press it.

NOTES:

- Protected images (🔒 pg. 39) cannot be deleted with the above operation. To delete them, remove protection first.
- Once images are deleted, they cannot be restored. Check images before deleting.

CAUTION:

Do not perform any other operation (such as turning off the camcorder) during deletion. Also, be sure to use the provided AC Power Adapter/Charger, as the memory may be corrupted if the battery becomes exhausted during deletion. If the memory becomes corrupted initialize it. (🔧 pg. 41)

Initializing The Built-in Memory

You can initialize the camcorder's built-in memory anytime.

After initializing, all images stored in the memory, including those which have been protected, are cleared.

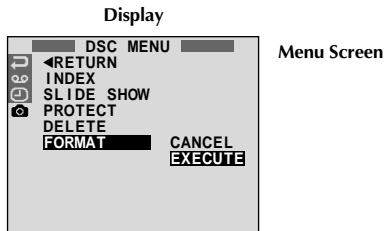
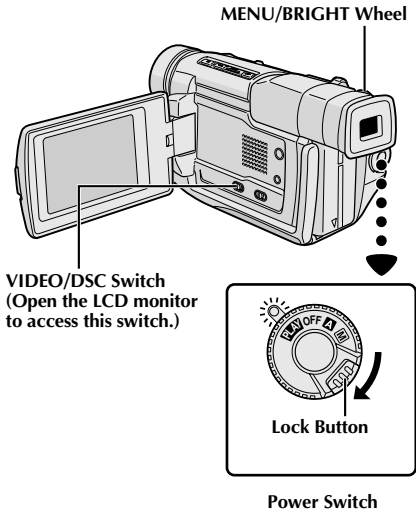

- 1 Set the **VIDEO/DSC** Switch to "**DSC**", then set the Power Switch to "**PLAY**", while pressing down the Lock Button located on the switch.
- 2 Press the **MENU/BRIGHT** wheel. The Menu Screen appears.
- 3 Rotate the **MENU/BRIGHT** wheel to select "**☒**" and press it. "DSC MENU" appears.
- 4 Rotate the **MENU/BRIGHT** wheel to select "FORMAT" and press it. The Sub Menu appears.
- 5 Rotate the **MENU/BRIGHT** wheel to select "EXECUTE" and press it. "FORMATTING IN PROGRESS" appears and the built-in memory is initialized. When initialization is finished, "NO IMAGES STORED" appears.
 - To cancel initialization, rotate the **MENU/BRIGHT** wheel to select "CANCEL" and press it.

CAUTION:

Do not perform any other operation (such as turning off the camcorder) during initialization. Also, be sure to use the provided AC Power Adapter/Charger, as the memory may be corrupted if the battery becomes exhausted during initialization. If the memory becomes corrupted initialize it again.

These are some basic types of connections. When making the connections, refer also to your VCR and TV instruction manuals.

A. Connection to a TV or VCR equipped with an S-VIDEO IN and A/V input connectors

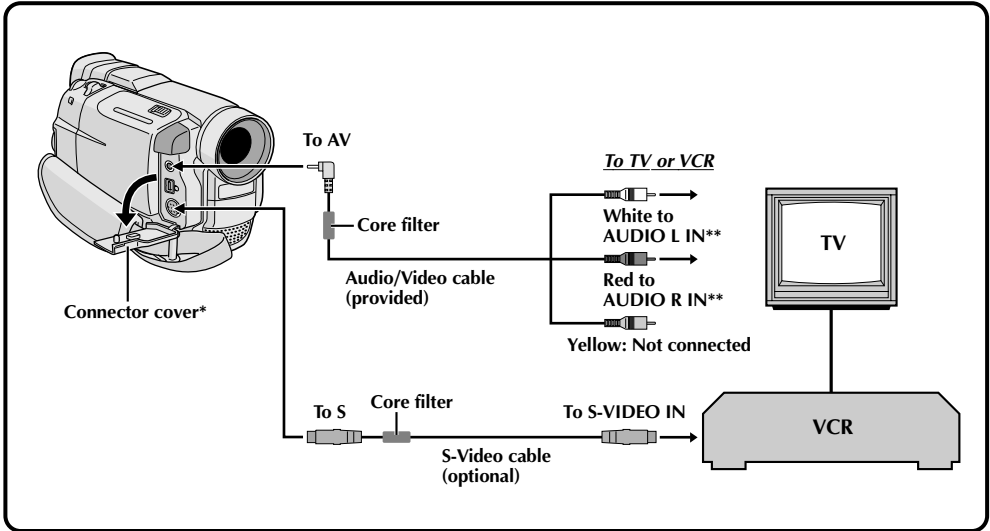

* When connecting the cables, open this cover.

** The Audio cable is not required for watching still images when the VIDEO/DSC Switch is set to "DSC".

B. Connection to a TV or VCR equipped only with A/V input connectors

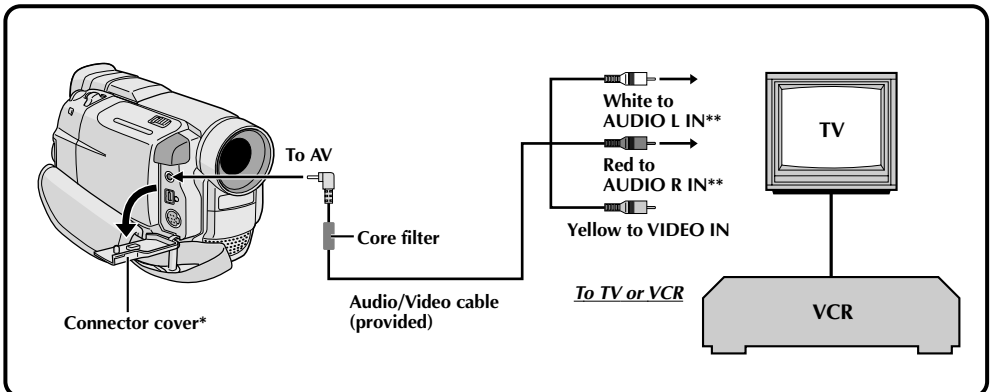

* When connecting the cables, open this cover.

** The Audio cable is not required for watching still images when the VIDEO/DSC Switch is set to "DSC".

- 1** Make sure all units are turned off.
- 2** Connect the camcorder to a TV or VCR as shown in the illustration (☞ pg. 42).
*If using a VCR . . . go to step 3.
If not . . . go to step 4.*
- 3** Connect the VCR output to the TV input, referring to your VCR's instruction manual.
- 4** Turn on the camcorder, the VCR and the TV.
- 5** Set the VCR to its AUX input mode, and set the TV to its VIDEO mode.

To choose whether or not the following displays appear on the connected TV . . .

- Date/Time
.... set "DATE/TIME" to "ON" or "OFF" in the Menu Screen (☞ pg. 34).
- Time Code
.... set "TIME CODE" to "ON" or "OFF" in the Menu Screen (☞ pg. 34).
- Playback Sound Mode, Tape Speed And Tape Running Displays for video playback

OR

Image Number/Total Number of Images for D.S.C. Playback
.... set "ON SCREEN" to "LCD" or "SIMPLE" in the Menu Screen (☞ pg. 34). Or, press **DISPLAY** on the remote control (provided).

NOTES:

- *It is recommended to use the AC Power Adapter/Charger as the power supply instead of the battery pack (☞ pg. 9).*
- *Use the provided Audio/Video cable, making sure to connect the end with a core filter to the camcorder. The core filter reduces interference.*
- *The S-Video cable is optional. Be sure to use the YTU94146A S-Video cable. Consult the JVC Service Center described on the sheet included in the package for details on its availability. Make sure to connect the end with a core filter to the camcorder. The core filter reduces interference.*
- *To monitor the picture and sound from the camcorder without inserting a tape, set the camcorder's Power Switch to "A" or "M", then set your TV to the appropriate input mode.*
- *Make sure you adjust the TV sound volume to its minimum level to avoid a sudden burst of sound when the camcorder is turned on.*
- *If you have a TV or speakers that are not specially shielded, do not place the speakers adjacent to the TV as interference will occur in the camcorder playback picture.*

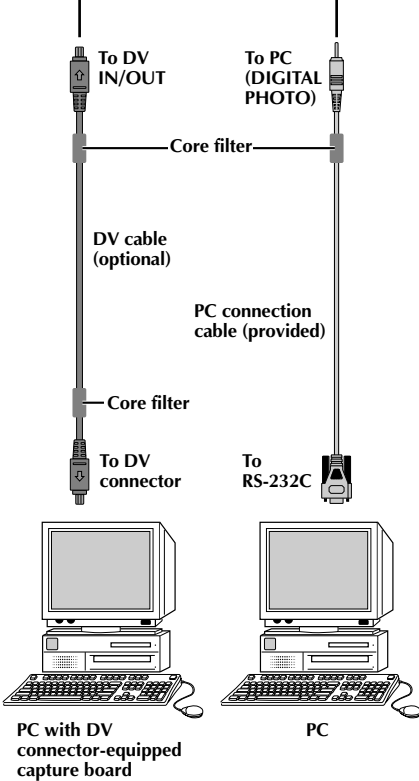
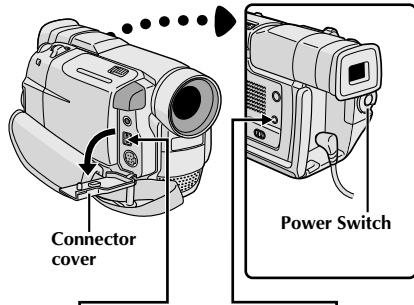

Connection To A Personal Computer

This camcorder can transfer still images to a PC by using the provided software when connected as shown in the illustration. It is also possible to transfer still images to a PC with a DV connector-equipped capture board installed.

- 1** Make sure the camcorder and PC are turned off.
- 2** Connect the camcorder to your PC using the appropriate cable as shown in the illustration.
- 3** Turn the camcorder's Power Switch to "PLAY" while pressing down the Lock Button located on the switch and turn on the PC.

NOTES:

- *It is recommended to use the AC Power Adapter/Charger as the power supply instead of the battery pack (pg. 9).*
- *Never connect the PC connection cable and the DV cable simultaneously to the camcorder. Connect only the cable you wish to use to the camcorder.*
- *The date/time information cannot be captured into the PC.*
- *Refer to the instruction manuals of the provided Software.*
- *Also refer to the manufacturer's instruction manual for the DV connector-equipped capture board.*
- *When using a DV cable, be sure it has a core filter attached. The core filter reduces interference.*

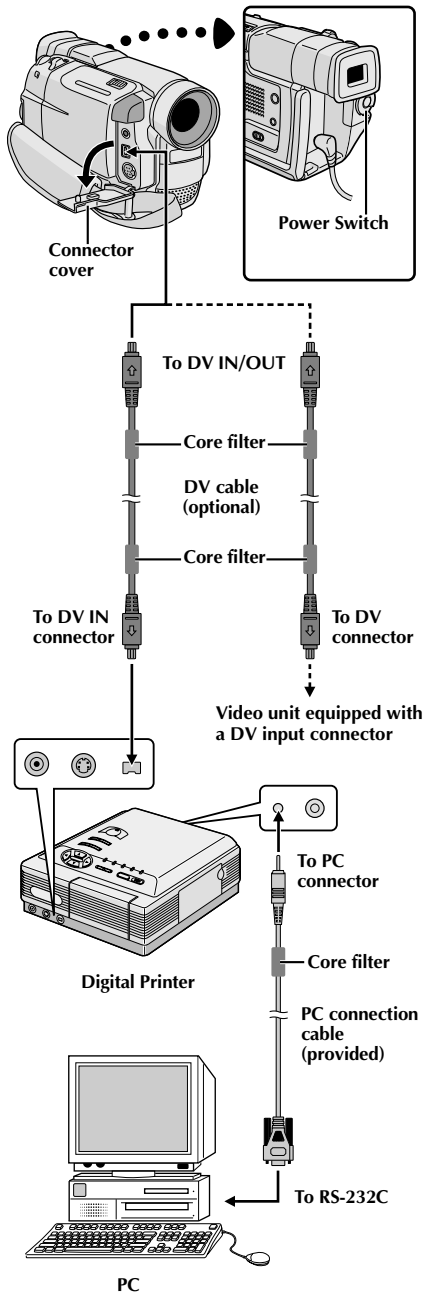

Connection To A Video Unit Equipped With A DV Connector

Connection to the GV-DT3 Digital Printer (optional) allows you to print out images or transfer them to a PC. It is also possible to copy recorded scenes from the camcorder onto another video unit equipped with a DV connector. This function is called Digital Dubbing (☞ pg. 47), which offers virtually no image or sound deterioration.

- 1** Make sure all units are turned off.
- 2** Make connections to the device you want to connect to using a DV cable, as shown in the illustration.
- 3** If necessary, connect the PC connection cable (provided) to the printer's PC connector and the PC's RS-232C connector.
- 4** Turn the camcorder's Power Switch to "PLAY" while pressing down the Lock Button located on the switch and turn on the other units.

NOTES:

- *It is recommended to use the AC Power Adapter/Charger as the power supply instead of the battery pack (☞ pg. 9).*
- *For Digital Dubbing, this camcorder can be connected only to one device at a time. This camcorder can also be used as a recorder (☞ pg. 47).*
- *If Still Playback, Slow-Motion Playback, Fast-Forward or Rewind is attempted with the camcorder connected to a video unit via the DV connector, the image will take on an effect similar to a colored mosaic pattern or it will become black.*
- *Also refer to the instruction manuals of the connected units.*
- *When using a DV cable, be sure it has a core filter attached. The core filter reduces interference.*

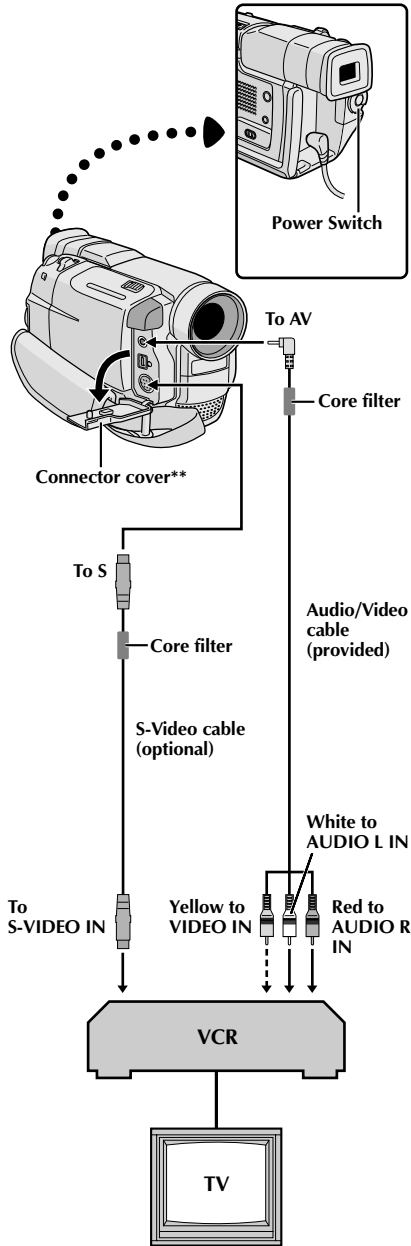

* Connect when an S-Video cable is not used.
 ** When connecting the cables, open this cover.

Dubbing To A VCR

- 1** Following the illustration, connect the camcorder and the VCR. Also refer to pg. 42 and 43.
- 2** Set the **VIDEO/DSC** Switch to "VIDEO", then set the camcorder's Power Switch to "PLAY" while pressing down the Lock Button located on the switch, turn on the VCR's power, and insert the appropriate cassettes in the camcorder and the VCR.
- 3** Engage the VCR's AUX and Record-Pause modes.
- 4** Engage the camcorder's Play mode to find a spot just before the edit-in point. Once it is reached, press **▶/||** on the camcorder.
- 5** Press **▶/||** on the camcorder and engage the VCR's Record mode.
- 6** Engage the VCR's Record-Pause mode and press **▶/||** on the camcorder.
- 7** Repeat steps 4 through 6 for additional editing, then stop the VCR and camcorder when finished.

NOTES:

- Use the provided Audio/Video cable, making sure to connect the end with a core filter to the camcorder. The core filter reduces interference.
- The S-Video cable is optional. Be sure to use the YTU94146A S-Video cable. Consult the JVC Service Center described on the sheet included in the package for details on its availability. Make sure to connect the end with a core filter to the camcorder. The core filter reduces interference.
- You can use Playback Zoom (☞ pg. 52) or Playback Special Effects (☞ pg. 53) in step 5.
- Before you start dubbing, make sure that the indications do not appear on the connected TV. If they do, they are being recorded onto the new tape.

To choose whether or not the following displays appear on the connected TV . . .

- Date/Time
 set "DATE/TIME" to "ON" or "OFF" in the Menu Screen (☞ pg. 34).
- Time Code
 set "TIME CODE" to "ON" or "OFF" in the Menu Screen (☞ pg. 34).
- Playback Sound Mode, Tape Speed And Tape Running Displays
 set "ON SCREEN" to "LCD" or "SIMPLE" in the Menu Screen (☞ pg. 34). Or, press **DISPLAY** on the remote control.

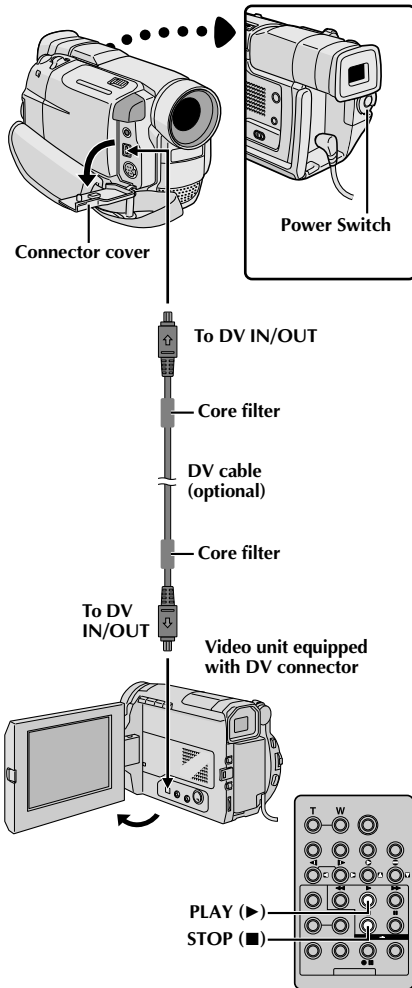

Dubbing To Or From A Video Unit Equipped With A DV Connector (Digital Dubbing)

It is also possible to copy recorded scenes from the camcorder onto another video unit equipped with a DV connector. Since a digital signal is sent, there is little if any image or sound deterioration.

[To use this camcorder as a player]

- 1 Make sure the camcorder's power is off.
- 2 Connect the camcorder to your video unit equipped with a DV connector using a DV cable as shown in the illustration.
- 3 Press ► to play back the source tape.
- 4 While watching the playback on the monitor, engage the DV connector-equipped video unit's record mode from the spot on the source tape you want to begin recording.

NOTES:

- It is recommended to use the AC Power Adapter/Charger as the power supply instead of the battery pack (☞ pg. 9).
- If the remote control is used when both the player and recorder are JVC video units, both units will perform the same operation. To prevent this from happening, press the buttons on both units.
- For Digital Dubbing, this camcorder can be connected only to one device at a time. This camcorder can also be used as a recorder.
- If a blank portion or disturbed image is played back on the player during dubbing, the dubbing may stop so that an unusual image is not dubbed.
- Even though the DV cable is connected correctly, sometimes the image may not appear in step 3. If this occurs, turn off the power and make connections again.
- If "Playback Zoom" (☞ pg. 52), "Playback Special Effects" (☞ pg. 53) or "Snapshot" is attempted during playback, only the original playback image recorded on the tape is output from the DV IN/OUT connector.
- When using a DV cable, be sure it has a core filter attached. The core filter reduces interference.

To Use This Camcorder As A Recorder . . .

1. Set the VIDEO/DSC Switch to "VIDEO", then turn the Power Switch to "PLAY" while pressing down the Lock Button located on the switch.
2. Set "REC MODE" to "SP" or "LP" in the Menu Screen (☞ pg. 34)
3. Connect the DV cable as shown in the illustration and load a cassette to record on.
4. Press the Recording Start/Stop button to engage the Record-Pause mode. "DV. IN" appears on the screen.
5. Press the Recording Start/Stop button to start recording. "DV. IN" changes to "DV.IN".
6. Press the Recording Start/Stop button again to engage the Record-Pause mode. "DV.IN" returns to "DV. IN".

NOTES:

- Digital Dubbing is performed in the sound mode recorded on the original tape, regardless of the current "SOUND MODE" setting (☞ pg. 25).
- During Digital Dubbing, no signals are output from the video or audio connectors.

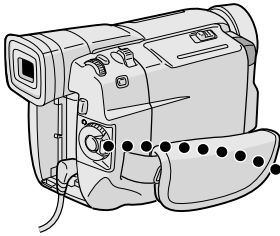

Power Switch

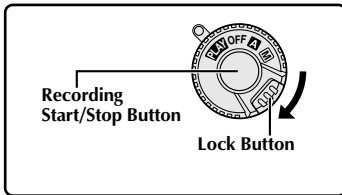

Rewind Button (◀◀)

Fast-Forward Button (▶▶)

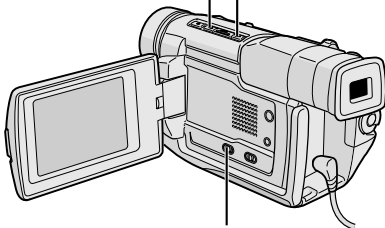

VIDEO/DSC Switch (Open the LCD monitor to access this switch.)

Display



Dubbing Images Stored In The Built-in Memory To A Tape

Images can be dubbed from the camcorder's built-in memory to a tape.

- 1 Load a cassette (☞ pg. 12).
- 2 To locate the point where you wish to dub a still image, play back the tape. Stop playback at the desired point.
- 3 Set the VIDEO/DSC Switch to "DSC", then set the Power Switch to "PLAY" while pressing down the Lock Button located on the switch.
- 4 To select a still image to be dubbed, perform Index Playback (☞ pg. 37) or press ◀◀ or ▶▶ to select the image you wish.
- 5 To engage Dub-Standby, press the Recording Start/Stop Button. The message "TO COPY TO TAPE PUSH START/STOP" appears.
- 6 While the message is being displayed, press the Recording Start/Stop Button. The selected still image is recorded on the tape for approx. 5 seconds.
 - The REC indicator disappears when dubbing is complete.

NOTE:

If the Recording Start/Stop Button is pressed in step 5 when the tape's erase protection tab is set to "SAVE", the message "COPYING FAILED" is displayed.

Dubbing Images Recorded On A Tape To The Built-in Memory

Images can be dubbed from a tape to the camcorder's built-in memory.

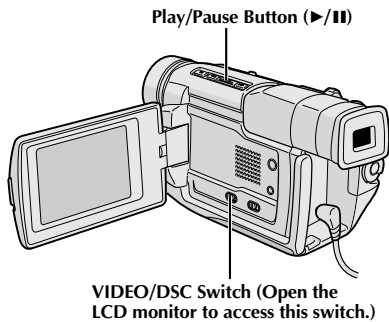
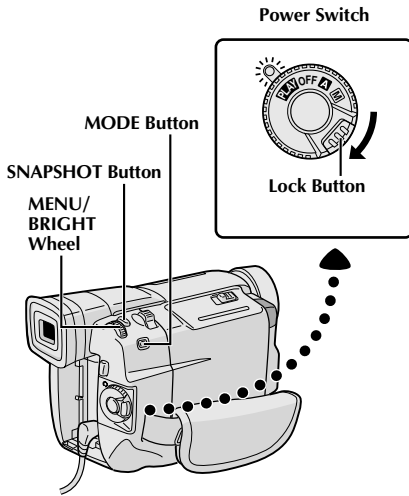

VIDEO/DSC Switch (Open the LCD monitor to access this switch.)

Display

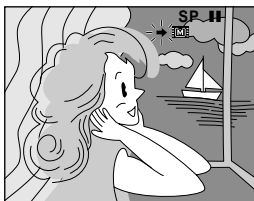

- 1 Load a cassette (☞ pg. 12).
- 2 Set the **VIDEO/DSC** Switch to "VIDEO", then set the Power Switch to "PLAY" while pressing down the Lock Button.
- 3 Press the **MENU/BRIGHT** wheel. The Menu Screen appears. Rotate it to select "☞" and press it. "VIDEO MENU" appears.
- 4 Rotate the **MENU/BRIGHT** wheel to select "☞ → [MEM] COPY" and press it. The Sub Menu appears. Rotate it to select "ON" and press it. Selection is complete.
- 5 Rotate the **MENU/BRIGHT** wheel to select "◀RETURN" and press it twice. The normal playback screen resumes.
- 6 To select a video image to be dubbed, start playback by pressing ▶/II. At the moment you find the image you wish to dub, press it again to engage Still Playback.
- 7 Press **MODE** to select the Snapshot mode to use for dubbing the image to the built-in memory.
- 8 To start dubbing, press **SNAPSHOT**. The selected image is stored in the built-in memory. •"→" blinks during dubbing.

NOTES:

- If **SNAPSHOT** is pressed in step 8 when the built-in memory is full, the message "COPYING FAILED" appears.
- If an image recorded on the tape using the **WIDE** mode (☞ pg. 26) is dubbed to the camcorder's built-in memory, the **WIDE** mode identifying signal is not dubbed with it.
- To use Playback Special Effects with a video image you wish to dub, perform up to step 8 using the remote control (provided) (☞ pg. 53).

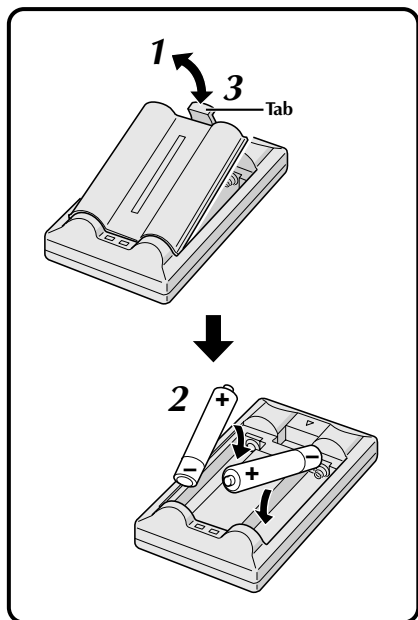

The Full-Function Remote Control Unit can operate this camcorder from a distance as well as the basic operations (Playback, Stop, Pause, Fast-Forward and Rewind) of your VCR. It also makes additional playback functions possible.

Installing The Batteries

The remote control uses two "AAA (R03)" size batteries. See "General Battery Precautions" (☞ pg. 77).

- 1** Remove the battery compartment cover while pushing up the tab as illustrated.
- 2** Insert two "AAA (R03)" size batteries in the correct direction.
- 3** Re-attach the battery compartment cover.

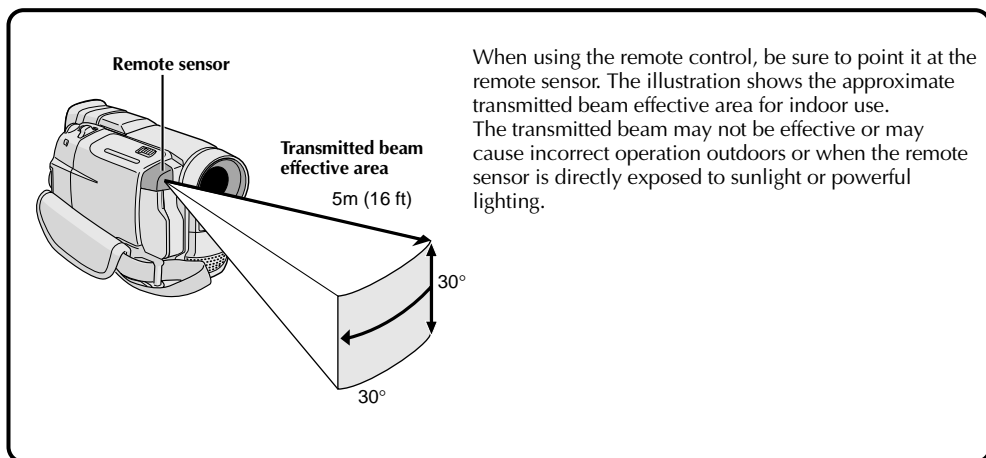

When using the remote control, be sure to point it at the remote sensor. The illustration shows the approximate transmitted beam effective area for indoor use. The transmitted beam may not be effective or may cause incorrect operation outdoors or when the remote sensor is directly exposed to sunlight or powerful lighting.

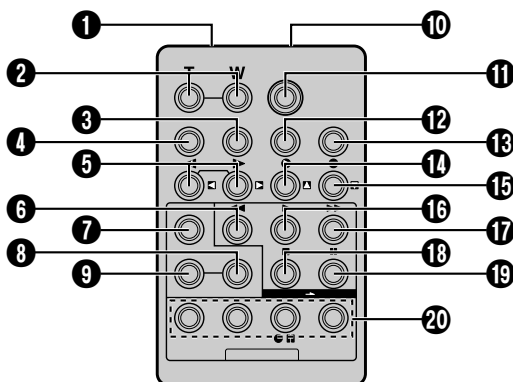

Buttons	Functions	
	With the camcorder's Power Switch set to the camera position ("A" or "M").	With the camcorder's Power Switch set to "PLAY".
1 Infrared beam transmitting window	Transmits the beam signal.	
2 Zoom (T/W) Buttons	Zoom in/out (☞ pg. 20)	Zoom in/out (☞ pg. 52)
3 DISPLAY Button	—	☞ pg. 43, 46, 55
4 SHIFT Button	—	☞ pg. 52, 54
5 SLOW Rewind/Forward Buttons Left/Right Buttons	— —	☞ pg. 52 ☞ pg. 52
6 REW Button	—	<ul style="list-style-type: none"> • Rewind/Reverse Shuttle Search on a tape (☞ pg. 33) • Displays previous image in the built-in memory (☞ pg. 36)
7 FADE/WIPE Button	—	☞ pg. 56
8 EFFECT ON/OFF Button	—	☞ pg. 53
9 EFFECT Button	—	☞ pg. 53
10 PAUSE IN Connector	—	☞ pg. 55
11 START/STOP Button	Functions the same as the Recording Start/Stop Button on the camcorder.	
12 MBR SET Button	—	☞ pg. 54
13 SNAPSHOT Button	Functions the same as SNAPSHOT on the camcorder.	
14 Up Button INSERT Button	— —	☞ pg. 52 ☞ pg. 61
15 Down Button A. DUB Button	— —	☞ pg. 52 ☞ pg. 60
16 PLAY Button	—	<ul style="list-style-type: none"> • Starts Playback of a tape (☞ pg. 33) • Starts Slide Show (☞ pg. 38)
17 FF Button	—	<ul style="list-style-type: none"> • Forward/Forward Shuttle Search on a tape (☞ pg. 33) • Displays next image in the built-in memory (☞ pg. 36)
18 STOP Button	—	<ul style="list-style-type: none"> • Stops the tape (☞ pg. 33) • Stops Slide Show (☞ pg. 38)
19 PAUSE Button	—	Pauses the tape (☞ pg. 52)
20 R.A.EDIT Buttons	—	☞ pg. 54 – 59

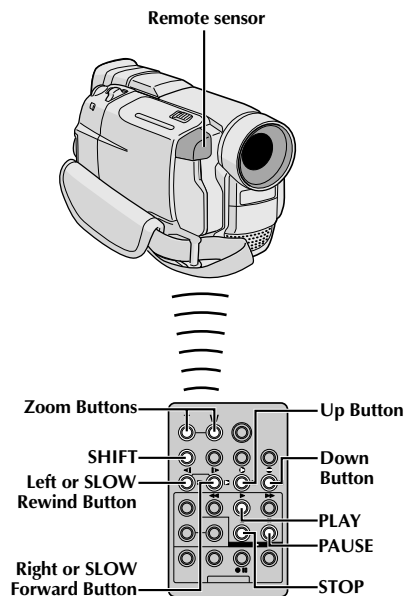

Normal playback

Press T



To move image,
press **▶** (Right)
while keeping
SHIFT held down.

FEATURE: Slow-Motion Playback

PURPOSE:

To allow slow-speed search in either direction during video playback.

OPERATION:

- 1) To change from normal to Slow-Motion Playback, press **PAUSE (II)** to engage Still Playback then press **SLOW (◀ or ▶)** more than approx. 2 seconds. After approx. 1 minute in Slow Rewind or approx. 2 minutes in Slow Forward, normal playback resumes.
 - To stop Slow-Motion Playback, press **PLAY (▶)**.

NOTES:

- During Slow-Motion Playback, due to digital image processing, the picture may take on a mosaic effect.
- After **SLOW (◀ or ▶)** is pressed and held, the still image may be displayed for a few seconds, followed by a blue screen for a few seconds. This is not a malfunction.
- There may be a small margin between the slow-motion playback start point you chose and the actual start point for Slow-Motion Playback.
- During Slow-Motion Playback, there will be disturbances in video and the picture may seem unstable, especially with steady images. This is not a malfunction.
- During Slow-Motion Playback, press **PAUSE (II)** to pause playback.

FEATURE: Frame-By-Frame Playback

PURPOSE:

To allow frame-by-frame search during video playback.

OPERATION:

- 1) To change from normal to Frame-By-Frame Playback, press **PAUSE (II)** to engage Still Playback then press **SLOW (▶)** repeatedly for forward or **SLOW (◀)** repeatedly for reverse. Each time it is pressed, the frame is played back.

FEATURE: Playback Zoom

PURPOSE:

To magnify the recorded image up to 25X at any time during playback.

OPERATION:





- 1) Press **PLAY (▶)** to find the scene of interest.
- 2) Press the Zoom Buttons (**T/W**) on the remote control. Make sure the remote control is pointed at the camcorder's remote sensor. Pressing **T** zooms in.
- 3) You can move the image on screen around to find a particular portion of the picture. While holding down **SHIFT**, press **◀** (Left), **▶** (Right), **▲** (Up) and **▼** (Down).
 - To end zoom, press and hold **W** until magnification returns to normal. Or, press **STOP (■)** and then press **PLAY (▶)**.

NOTES:

- Zoom can also be used during slow-motion and still playback.
- Due to digital image processing, the quality of the image may suffer.

PLAYBACK EFFECT

▶OFF

- 1  CLASSIC FILM
- 2  B/W MONOTONE
- 3  SEPIA
- 4  STROBE
- 5  VIDEO ECHO

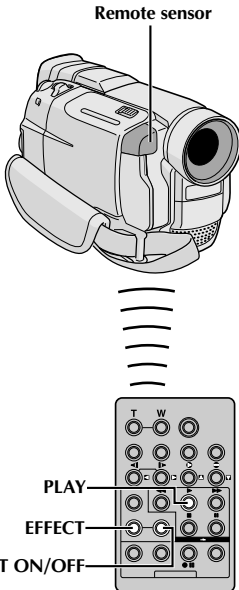
PLAYBACK
EFFECT Select
Menu**FEATURE: Playback Special Effects****PURPOSE:**

To allow you to add creative effects to the video playback image.

OPERATION:

- 1) To start playback, press **PLAY** (▶).
- 2) Point the remote control at the camcorder's remote sensor and press **EFFECT**. The **PLAYBACK EFFECT Select Menu** appears.
- 3) Move the highlight bar to the desired effect by pressing **EFFECT**. The selected function is activated and after 2 seconds the menu disappears.
 - To deactivate the selected effect, press **EFFECT ON/OFF** on the remote control. Pressing it again re-activates the selected effect.
 - To change the selected effect, repeat from step 2 above.

NOTES:

- When some Playback Special Effects are used, the Multi-Analyzer 4 and Multi-Analyzer 9 Snapshot modes (📷 pg. 18) are not available.
- The effects that can be used during playback are Classic Film, Monotone, Sepia, Strobe and Video Echo. The effects work the same in playback as they did in recording. Refer to page 30 for more information.

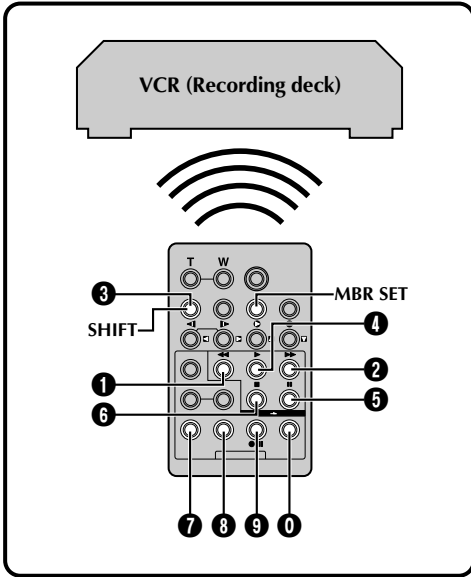

Random Assemble Editing [R.A.Edit]

Create edited videos easily using your camcorder as the source player. You can select up to 8 “cuts” for automatic editing, in any order you like. R.A.Edit is more easily performed when the MBR (Multi-Brand Remote) is set to operate with your brand of VCR (see VCR CODE LIST), but can also be performed by operating the VCR manually. Before operation, make sure the batteries are installed in the remote control (☞ pg. 50).

SET REMOTE/VCR CODE

1 Turn off the power to the VCR and point the remote towards the VCR’s infrared sensor. Then, referring to the VCR CODE LIST, press and hold **MBR SET**, and press button (A) and then (B). The code is automatically set once you release **MBR SET**, and the VCR’s power comes on.

2 Make sure the VCR’s power is on. Then, while holding **SHIFT**, press the button on the remote for the desired function. The functions the remote can control are PLAY, STOP, PAUSE, FF, REW and VCR REC STBY (you do not need to press **SHIFT** for this one).

You are now ready to try Random Assemble Editing.

IMPORTANT

Although the MBR is compatible with JVC VCRs and those of many other makers, it may not work with yours or may offer limited functions.

NOTES:

- If the VCR’s power does not come on in step 1, try another code from the VCR CODE LIST.
- Some brands of VCR do not come on automatically. In this case, turn the power on manually and try step 2.
- If the remote control is not able to control the VCR, use the controls on the VCR.
- When the remote control’s batteries run out, the VCR brand you have set will be erased. In that case, replace the old battery with a new one to reset the VCR brand.

VCR CODE LIST

VCR BRAND NAME	BUTTONS (A) (B)	VCR BRAND NAME	BUTTONS (A) (B)
GE	1 1	PHILIPS	3 3
	9 2		7 2
	9 0	PANASONIC	1 3
	9 4		1 7
HITACHI	6 6	1 1	9 4
	6 3	1 8	
JVC A B C	9 1	RCA	9 2
	9 6		9 4
	9 3		6 6
MAGNAVOX	9 5	6 3	9 0
	1 1	SANYO	3 6
	7 1		3 5
	7 6	SHARP	1 5
	1 0		
MITSUBISHI	6 7	SONY	6 5
	6 8		6 0
			3 9
NEC	3 7	3 1	TOSHIBA
	3 8	6 9	
			6 1
PHILIPS	1 9	ZENITH	1 6
	9 5		
	1 1		
	9 4		
	9 1		
	9 6		
1 2			

MAKE CONNECTIONS

Also refer to pg. 42 and 43.

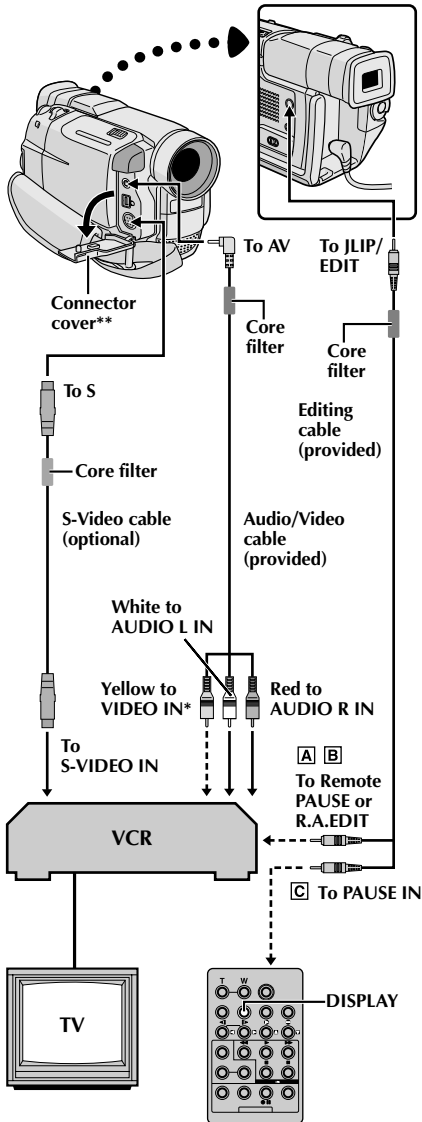

* Connect when an S-Video cable is not used.
 ** When connecting cables, open this cover.

ATTENTION FOR EDITING CABLE

Make sure you connect the end with the core filter (plug which has 3 rings around the pin) to the camcorder.

- 1** **A** A JVC VCR equipped with a remote pause connector . . .
 ... connect the editing cable to the Remote PAUSE connector.
- B** A JVC VCR not equipped with a remote pause connector but equipped with an R.A. EDIT connector . . .
 ... connect the editing cable to the R.A.EDIT connector.
- C** A VCR other than above . . .
 ... connect the editing cable to the remote control's PAUSE IN connector.

2 Insert a recorded tape into the camcorder. Set the VIDEO/DSC Switch to "VIDEO", then set the Power Switch to "PLAY" while pressing down the Lock Button located on the switch.

3 Turn the VCR power on, insert a recordable tape and engage the AUX mode (refer to the VCR's instructions).

NOTES:

- Before Random Assemble Editing, make sure the indications do not appear on the TV monitor. If they do, they will be recorded onto the new tape.

To choose whether or not the following displays appear on the connected TV . . .

- Date/Time
 set "DATE/TIME" to "ON" or "OFF" in the Menu Screen (☞ pg. 34).
- Time Code
 set "TIME CODE" to "ON" or "OFF" in the Menu Screen (☞ pg. 34).
- Playback Sound Mode, Tape Speed And Tape Running Displays
 set "ON SCREEN" to "LCD" or "SIMPLE" in the Menu Screen (☞ pg. 34). Or, press **DISPLAY** on the remote control.
- Use the provided cables, making sure to connect the end with a core filter to the camcorder. The core filter reduces interference.
- The S-Video cable is optional. Be sure to use the YTU94146A S-Video cable.
Consult the JVC Service Center described on the sheet included in the package for details on its availability. Make sure to connect the end with a core filter to the camcorder. The core filter reduces interference.
- When editing on a VCR equipped with a DV input connector, an optional DV cable can be connected instead of an S-Video cable and audio/video cable.

CONTINUED ON NEXT PAGE

Program

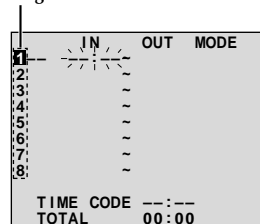

Random Assemble Editing Menu

Remote sensor

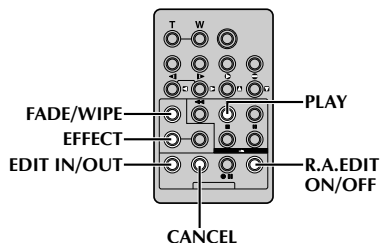
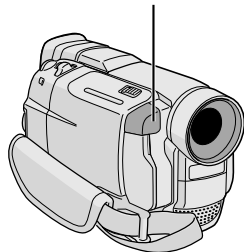

SELECT SCENES

- 4 Point the remote control at the camcorder's remote sensor. Press **PLAY** (▶) and then press **R.A.EDIT ON/OFF** on the remote control. The Random Assemble Editing Menu appears.
- 5 If using a Fade/Wipe at the beginning of the scene, press **FADE/WIPE** on the remote control.
 - Cycle through the effects by pressing repeatedly, and stop when the one you want is displayed.
 - You cannot use a Picture Wipe/Dissolve at the beginning of Program 1.
- 6 At the beginning of the scene, press **EDIT IN/OUT** on the remote control. The Edit-In position appears in the Random Assemble Editing Menu.
- 7 At the end of the scene, press **EDIT IN/OUT**. The Edit-Out position appears in the Random Assemble Editing Menu.
- 8 If using a Fade/Wipe at the end of the scene, press **FADE/WIPE**.
 - Cycle through the effects by pressing repeatedly, and stop when the one you want is displayed.
 - If you select a Fade/Wipe effect for an Edit-Out point, the effect is automatically applied to the following Edit-In point.
 - You cannot use a Picture Wipe/Dissolve at the end of the last scene.
 - When you use Fade/Wipe effects, that time is included in the total time (this does not apply to Picture Wipe/Dissolve).
- 9 If using Playback Special Effects, press **EFFECT** (⏮ pg. 53).
- 10 Repeat steps 6 through 9 to register additional scenes.
 - To change previously registered points, press **CANCEL** on the remote control. The registered points disappear, one at a time, from the most recently registered point.
 - If you are not using Fade/Wipe or Program AE with special effects, repeat steps 6 and 7 only.

NOTES:

- When choosing a scene, set Edit-In and Edit-Out points so that there is a relatively large difference between them.
- If the search time for an in-point exceeds 5 minutes, the recording deck's Record-Standby mode will be canceled and editing will not take place.
- If there are blank portions before or after the Edit-In and Edit-Out points, a blue screen may be included in the edited version.
- Since time codes register time only as accurately as seconds, the time code total time may not match the total program time exactly.
- Turning off the camcorder's power erases all registered Edit-In and Edit-Out points.
- If you select Sepia or Monotone mode from Program AE with special effects, you cannot use the Dissolve or Black & White Fader. In this case the Dissolve or Black & White indicator begins blinking. Once the next Edit-In point is registered, the effect is turned off. To combine these effects, use Sepia or Monotone during recording, then use the Dissolve or Black & White Fader during Random Assemble Editing.
- It is not possible to use Fade/Wipe effects and Program AE with special effects during Random Assemble Editing using a DV cable.

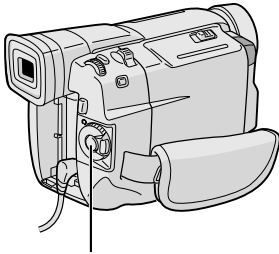

Recording Start/Stop Button

	IN	OUT	MODE
1	00:25	02:05	P
2	07:18	08:31	--
3	03:33	05:53	B/W
4	09:30	13:15	☑
5	15:55	16:20	☑
6			
7			
8			
TIME CODE		16:30	
TOTAL		9:39	

Random Assemble Editing Menu

Remote Sensor

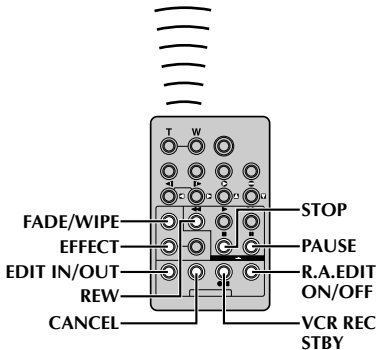
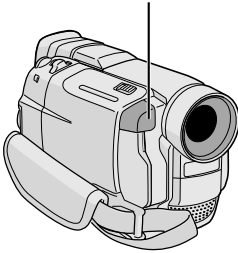

AUTOMATIC EDITING TO VCR

- 11** Rewind the tape in the camcorder to the beginning of the scene you want to edit and press **PAUSE (II)**.
- 12** Point the remote control towards the VCR's remote sensor and press **VCR REC STBY (●II)**, or manually engage the VCR's Record-Pause mode.
- 13** Press the Recording Start/Stop Button on the camcorder. Editing proceeds as programmed, right through to the end of the last registered scene.
 - Pressing **START/STOP** on the remote control does not start editing.
 - When dubbing is complete, the camcorder enters the Pause mode, and the VCR enters its Record-Pause mode.
 - If you do not register an Edit-Out point, the tape will be dubbed all the way to the end automatically.
 - If you operate the camcorder during automatic editing, the VCR will enter its Record-Pause mode and automatic editing will stop.
- 14** Engage the Stop modes for the camcorder and the VCR.
To make the R.A.Edit counter display disappear, press **R.A.EDIT ON/OFF** on the remote control.

NOTES:

- Pressing **R.A.EDIT ON/OFF** on the remote control clears all settings registered during Random Assemble Editing.
- When the editing cable is connected to the remote control's Pause In connector during dubbing, make sure the remote control is pointed at the VCR's sensor, and the path between the two is unobstructed.
- Random Assemble Editing may not function properly when using a tape including several duplicated time codes (☞ pg. 21).

Program 1

	IN	OUT	MODE
1	---	---	---
2	---	---	---
3	---	---	---
4	---	---	---
5	---	---	---
6	---	---	---
7	---	---	---
8	---	---	---

TIME CODE ---:--
TOTAL 00:00

Random Assemble Editing Menu

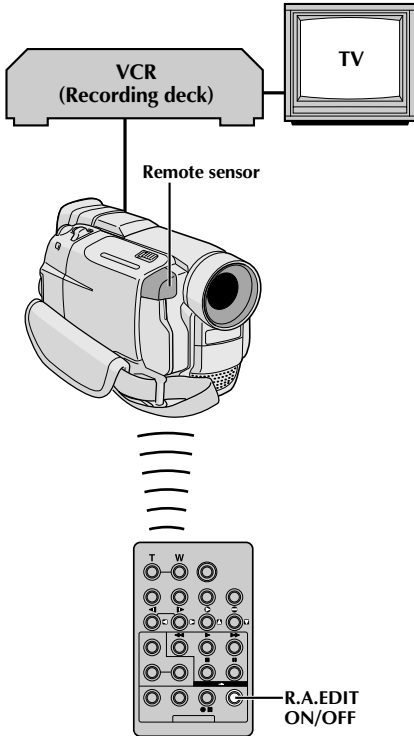

For More Accurate Editing

Some VCRs make the transition from Record-Pause to Record mode faster than others. Even if you begin editing for the camcorder and the VCR at exactly the same time, you may lose scenes you wanted, or find that you have recorded scenes you did not want. For a cleanly edited tape, confirm and adjust the timing of the camcorder against your VCR.

DIAGNOSING VCR/CAMCORDER TIMING

- 1 Play back the tape in the camcorder, then point the remote control at the camcorder's remote sensor and press **R.A.EDIT ON/OFF**.
The Random Assemble Editing Menu appears.
- 2 Perform Random Assemble Editing on Program 1 only. In order to check VCR and camcorder timing, select the beginning of a scene transition as your Edit-In point.
- 3 Play back the dubbed scene.
 - If any images from the scene prior to the transition you chose for your Edit-In point were recorded, that means your VCR moves too quickly from Record-Pause to Record mode.
 - If the scene you tried to dub starts in progress, the VCR is slow to start recording.

MENU/BRIGHT Wheel

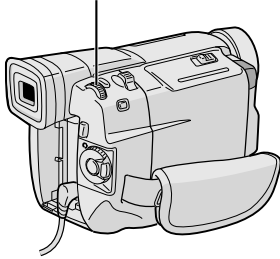

Display

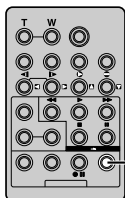
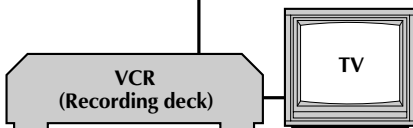
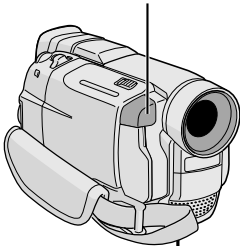

Remote sensor

R.A.EDIT
ON/OFF

ADJUSTMENT OF VCR/CAMCORDER TIMING

- 4** Point the remote control at the camcorder's remote sensor and press **R.A.EDIT ON/OFF** to make the Random Assemble Editing menu disappear, then press the **MENU/BRIGHT** wheel. The Menu Screen appears.
- 5** Rotate the **MENU/BRIGHT** wheel to select "**☒**" and press it. "VIDEO MENU" appears. Then, rotate it to "SYNCHRO" and press it. The value for "SYNCHRO" is highlighted.
- 6** Based on the diagnostics performed (☞ pg. 58), you can now advance the VCR's record timing by rotating the **MENU/BRIGHT** wheel towards "+". You can also delay the VCR's record timing by rotating the **MENU/BRIGHT** wheel towards "-". The adjustment range is from -1.3 to +1.3 seconds, in 0.1-second increments. Press the **MENU/BRIGHT** wheel to finish the setting.
- 7** Rotate the **MENU/BRIGHT** wheel to select "**◀RETURN**" and press it twice. Now perform Random Assemble Editing beginning with step 4 on page 56.

NOTES:

- Before performing actual Random Assemble Editing, do a few Random Assemble Editing trial runs to check whether the value you have input is appropriate or not, and make adjustments accordingly.
- Depending on the recorder, there may be situations where the timing difference cannot be fully corrected.

Display

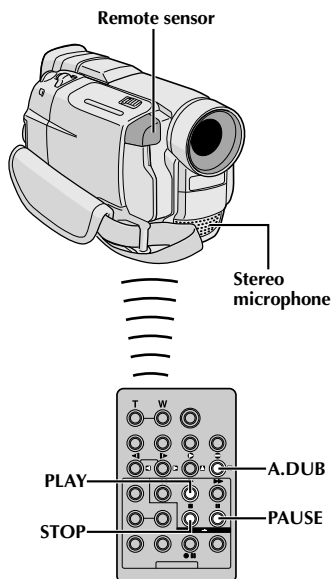
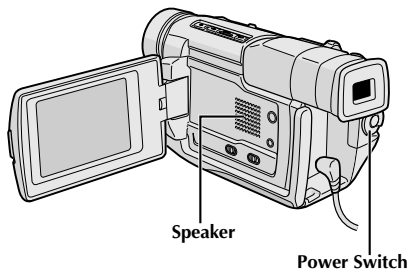
Audio Dub
Standby mode

Audio Dubbing

The audio track can be customized only when recorded in the 12-bit mode (☞ pg. 25).

NOTES:

- Audio Dubbing is not possible on a tape recorded in 16-bit audio, on a tape recorded in the LP mode or on a blank portion of a tape.
- To perform Audio Dubbing while watching on the television, make connections (☞ pg. 42).

- 1 Play back the tape to locate the point where editing will start, then press **PAUSE (II)**.
- 2 While holding **A.DUB (⊖)** on the remote control, press **PAUSE (II)**. "II⊖" appears.
- 3 Press **PLAY (▶)**, then begin "narrating".
Speak into the microphone.
• To pause dubbing, press **PAUSE (II)**.
- 4 To end Audio Dubbing, press **PAUSE (II)**, then **STOP (■)**.

To hear the dubbed sound during playback . . .

.... set "12BIT MODE" to "SOUND 2" or "MIX" in the Menu Screen (☞ pg. 34, 35).

NOTES:

- Sound is not heard from the speaker during Audio Dubbing.
- When editing onto a tape that was recorded at 12-bit, the old and new soundtracks are recorded separately.
- If you dub onto a blank space on the tape, the sound may be disrupted. Make sure you only edit recorded areas.
- If feedback or howling occurs during TV playback, move the camcorder's microphone away from the TV, or turn down the TV's volume.
- If you change from 12-bit to 16-bit in mid-recording and then use the tape for Audio Dubbing, it is not effective from the point where 16-bit recording began.
- During Audio Dubbing, when the tape moves to scenes recorded in the LP mode, scenes recorded in 16-bit audio or a blank portion, Audio Dubbing stops (☞ pg. 73).

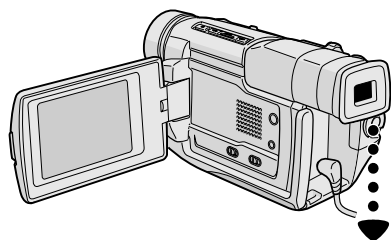

Display

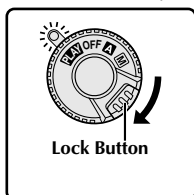
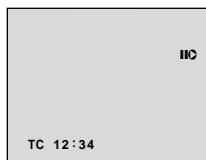

Lock Button

Power Switch

Remote sensor

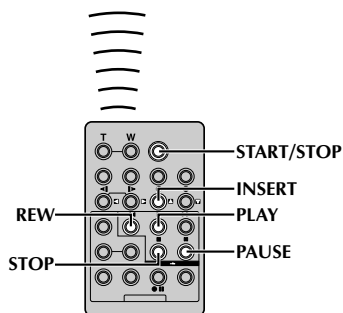
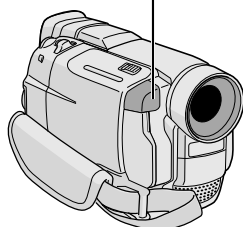

Insert Editing

You can record a new scene into a previously recorded tape, replacing a section of the original recording with minimal picture distortion at the in and out points. The original audio remains unchanged.

NOTES:

- Before performing the following steps, make sure that "TIME CODE" is set to "ON" in the Menu Screen (☞ pg. 34).
- Insert Editing is not possible on a tape recorded in the LP mode or on a blank portion of a tape.
- To perform Insert Editing while watching in the television, make connections (☞ pg. 42).

- 1 Play back the tape, locate the Edit-Out point and press **PAUSE (II)**. Confirm the time code at this point (☞ pg. 35).
- 2 Press **REW (◀◀)** until the Edit-In point is located, then press **PAUSE (II)**.
- 3 Press and hold **INSERT (Ⓞ)** on the remote control, then press **PAUSE (II)**. "IIⓄ" and the Time Code (min.:sec.) appear and the camcorder enters Insert-Pause mode.
- 4 Press **START/STOP** to begin editing.
 - Confirm the insert at the time code you checked in step 1.
 - To pause editing, press **START/STOP**. Press it again to resume editing.
- 5 To end Insert Editing, press **START/STOP**, then **STOP (■)**.

NOTES:

- Program AE with special effects (☞ pg. 30) can be used to spice up the scenes being edited during Insert Editing.
- During Insert Editing, the date and time information changes.
- If you perform Insert Editing onto a blank space on the tape, the audio and video may be disrupted. Make sure you only edit recorded areas.
- During Insert Editing, when the tape moves to scenes recorded in the LP mode or a blank portion, Insert Editing stops (☞ pg. 73).

If, after following the steps in the chart below, the problem still exists, please consult your nearest JVC dealer.

The camcorder is a microcomputer-controlled device. External noise and interference (from a TV, a radio, etc.) might prevent it from functioning properly. In such cases, first disconnect its power supply unit (battery pack, AC Power Adapter/Battery Charger, etc.) and wait a few minutes; and then re-connect it and proceed as usual from the beginning.

SYMPTOM	POSSIBLE CAUSES	CORRECTIVE ACTION
1. No power is supplied.	1. • The power is not connected properly. • The battery is dead.	1. • Connect the AC Power Adapter/Charger securely (☞ pg. 9). • Replace the dead battery with a fully charged one (☞ pg. 8, 9).
2. "SET DATE/TIME!" appears.	2. • The date/time is not set. • The built-in clock battery has run out and the previously set date/time has been erased.	2. • Set the date/time (☞ pg. 11). • Consult your nearest JVC dealer for replacement.
3. Recording cannot be performed.	3. — For Video Recording — • The tape's erase protection tab is set to "SAVE". • The Power Switch is set to "PLAY" or "OFF". • The VIDEO/DSC Switch is set to "DSC". • "TAPE END" appears. • The cassette holder cover is open. — For D.S.C. Recording — • The VIDEO/DSC Switch is set to "VIDEO". • The camcorder's built-in memory is full.	3. • Set the tape's erase protection tab to "REC" (☞ pg. 12). • Set the Power Switch to "A" or "M" (☞ pg. 15). • Set the VIDEO/DSC Switch to "VIDEO". • Replace with new cassette (☞ pg. 12). • Close the cassette holder cover. • Set the VIDEO/DSC Switch to "DSC". • Delete unwanted still images (☞ pg. 40).
4. There is no picture.	4. • The camcorder is not getting power, or some other malfunction exists.	4. • Turn the camcorder's power off and on again (☞ pg. 15).
5. Some functions are not available using MENU/BRIGHT.	5. • The Power Switch is set to "A".	5. • Set the Power Switch to "M" (☞ pg. 15).
6. The focus does not adjust automatically.	6. • Focus is set to the Manual mode. • The recording was done in a dark place, or the contrast was low. • The lens is dirty or covered with condensation.	6. • Set Focus to the Auto mode (☞ pg. 23). • Clean the lens and check the focus again (☞ pg. 76).

SYMPTOM	POSSIBLE CAUSES	CORRECTIVE ACTION
7. The cassette will not load properly.	7. • The cassette is in the wrong position. • The battery's charge is low.	7. • Set it in the right position (☞ pg. 12). • Install a fully charged battery (☞ pg. 8, 9).
8. Snapshot mode cannot be used.	8. • The Squeeze mode is selected.	8. • Disengage the Squeeze mode (☞ pg. 26).
9. The color of Snapshot looks strange.	9. • The light source or the subject does not include white. Or there are various different light sources behind the subject. • The Sepia or Monotone mode is activated.	9. • Find a white subject and compose your shot so that it also appears in the frame (☞ pg. 18, 19). • Turn off Sepia and Monotone (☞ pg. 28).
10. The image taken using Snapshot is too dark.	10. • Shooting was performed under backlit conditions.	10. • Press the BACKLIGHT Button (☞ pg. 31).
11. Digital Zoom does not work.	11. • 10X optical zoom is selected. • "P.AE/EFFECT" is set to "VIDEO ECHO" in the Menu Screen. • Picture Wipe or Dissolve are being used in a scene transition.	11. • Set "ZOOM" to "40X" or "250X" in the Menu Screen (☞ pg. 25). • Disengage the "VIDEO ECHO" mode (☞ pg. 20, 30). • Wait until the Picture Wipe or Dissolve effects are completed (☞ pg. 20, 28).
12. Program AE with special effects and Fade/Wipe Effects do not work.	12. • The Power Switch is set to "A".	12. • Set the Power Switch to "M" (☞ pg. 28, 30).
13. The Black & White Fader does not work.	13. • The Sepia or Monotone mode is activated.	13. • Turn off Sepia and Monotone (☞ pg. 28, 30).
14. The Dissolve function does not work.	14. • The Sepia, Monotone or Slow Shutter mode of Program AE with special effects is activated. • "WIDE MODE" is set to "SQUEEZE" in the Menu Screen. • The previously selected mode of Program AE with special effects was changed after the last selected scene for editing was registered.	14. • Turn off Sepia, Monotone or Slow Shutter before adding Dissolve to a scene transition (☞ pg. 28, 30). • Set "WIDE MODE" to "CINEMA" or "OFF" mode (☞ pg. 26). • Make sure you have selected the mode of Program AE with special effects you want before starting editing (☞ pg. 28, 30).

CONTINUED ON NEXT PAGE

SYMPTOM	POSSIBLE CAUSES	CORRECTIVE ACTION
<p>15. The Picture Wipe and Dissolve functions do not work.</p>	<p>15.</p> <ul style="list-style-type: none"> • The last selected editing scene is ending. • At the end of the last selected scene for editing, the Power Switch was set to "OFF". • The power is off. 	<p>15.</p> <ul style="list-style-type: none"> • Select Picture Wipe or Dissolve before beginning recording. The effects are then automatically activated (☞ pg. 28). • Do not turn off the camcorder's power after setting Edit-In and Edit-Out points, as they will all be erased (☞ pg. 28). • The camcorder automatically shuts off after 5 minutes have elapsed in the Record-Standby mode. Make sure you continue operations within 5 minutes after engaging Record-Standby mode (☞ pg. 28).
<p>16. The picture wipe function does not work.</p>	<p>16</p> <ul style="list-style-type: none"> • The Slow Shutter mode is activated. • "WIDE MODE" is not set to "OFF". 	<p>16.</p> <ul style="list-style-type: none"> • Disengage the Slow Shutter mode or set "WIDE MODE" to "OFF" before preparing to use the Picture Wipe (☞ pg. 26, 28, 30).
<p>17. Scene transition does not go as expected.</p>	<p>17.</p> <ul style="list-style-type: none"> • When using "Picture Wipe/Dissolve" (☞ pg. 28), there is a delay of a fraction of a second between the previous record stop-point and the Dissolve start-point. This is normal, but this slight delay becomes especially noticeable when shooting fast-moving subject or during rapid panning. 	<p>17.</p> <p style="text-align: center;">_____</p>
<p>18. The Video Echo mode does not work.</p>	<p>18.</p> <ul style="list-style-type: none"> • The Picture Wipe or Dissolve functions are in use. • "WIDE MODE" is set to "SQUEEZE" in the Menu Screen. • A Fade-In or Fade-Out is in progress. 	<p>18.</p> <ul style="list-style-type: none"> • Set "WIDE MODE" to "CINEMA" or "OFF" mode (☞ pg. 26). • Do not try to use the Video Echo mode during a Fade-In or Fade-Out (☞ pg. 28, 30).

SYMPTOM	POSSIBLE CAUSES	CORRECTIVE ACTION
19. Even when Slow Shutter is not selected, the image looks like it is activated.	19 • When shooting in the dark, the unit becomes highly sensitive to light and the image takes on an effect similar to Slow Shutter.	19. • If you want the lighting to look more natural, set GAIN UP to "AGC" or "OFF" in the Menu Screen (☞ pg. 25).
20. There is no strobe when the Classic Film or Strobe mode is activated.	20. • The Picture Wipe or Dissolve function is in use.	20. • Do not try to use the Classic Film or Strobe mode during a scene transition (☞ pg. 28, 30).
21. White Balance cannot be activated.	21. • The Sepia or Monotone mode is activated.	21. • Turn off Sepia or Monotone before setting White Balance (☞ pg. 30, 32).
22. When shooting a subject illuminated by bright light, vertical lines appear.	22. • This is a result of exceedingly high contrast, and is not a malfunction.	22. _____
23. When the screen is under direct sunlight during shooting, the screen becomes red or black for an instant.	23. • This is not a malfunction.	23. _____
24. During recording, the date/time does not appear.	24. • "DATE/TIME" is set to "OFF" in the Menu Screen. • Self-Recording is performed.	24. • Set "DATE/TIME" to "ON" in the Menu Screen (☞ pg. 27). • During Self-Recording, the date/time does not appear (☞ pg. 17).
25. Images stored in the built-in memory cannot be deleted.	25. • Images stored in the built-in memory are protected.	25. • Remove protection from the images stored in the built-in memory and delete them (☞ pg. 39, 40).
26. The indicators and messages do not appear.	26. • "ON SCREEN" is set to "SIMPLE" or "TIME CODE" is set to "OFF" in the Menu Screen.	26. • Set "ON SCREEN" to "LCD" or "LCD/TV" and set "TIME CODE" to "ON" in the Menu Screen (☞ pg. 27, 34).

CONTINUED ON NEXT PAGE

SYMPTOM	POSSIBLE CAUSES	CORRECTIVE ACTION
27. Images on the LCD monitor appear dark or whitish.	27. • In places subject to low temperature, images become dark due to the characteristics of the LCD monitor. When this happens, the displayed colors differ from those that are actually recorded. This is not a defect of the camcorder. • When the LCD monitor's fluorescent light reaches the end of its service life, images on the LCD monitor become dark. Consult your nearest JVC dealer.	27. • Adjust the brightness and angle of the LCD monitor (☞ pg. 16, 17).
28. The rear of the LCD monitor is hot.	28. • The light used to illuminate the LCD monitor causes it to become hot.	28. • Close the LCD monitor to turn it off or set the Power Switch to "OFF", and let the unit cool down.
29. The indicators and the image color on the LCD monitor are not clear.	29. • This may occur when the surface or the edge of the LCD monitor is pressed.	29. _____
30. The LCD monitor or viewfinder indications blink.	30. • Certain Fade/Wipe effects, certain modes of Program AE with special effects, "DIS" and other functions that cannot be used together are selected at the same time.	30. • Re-read the sections covering Fade/Wipe effects, Program AE with special effects and "DIS" (☞ pg. 26, 28 – 30).
31. Colored bright spots appear all over the LCD monitor or the viewfinder.	31. • The LCD monitor and the viewfinder are made with high-precision technology. However, black spots or bright spots of light (red, green or blue) may appear constantly on the LCD monitor or the viewfinder. These spots are not recorded on the tape. This is not due to any defect of the unit. (Effective dots: more than 99.99%)	31. _____

SYMPTOM	POSSIBLE CAUSES	CORRECTIVE ACTION
32. During recording, sound cannot be heard.	32. • This is normal.	32. _____
33. Play, Rewind and Fast-Forward functions do not work.	33. • The Power Switch is not set to "PLAY".	33. • Set the Power Switch to "PLAY" (☞ pg. 33).
34. Images in the built-in memory cannot be played back.	34. • The VIDEO/DSC Switch is set to "VIDEO". • The Power Switch is set to "A" or "M".	34. • Set the VIDEO/DSC Switch to "DSC". • Set the Power Switch to "PLAY".
35. The tape is moving, but there is no picture.	35. • Your TV has AV input terminals, but is not set to its VIDEO mode. • The cassette holder cover is open.	35. • Set the TV to the mode or channel appropriate for video playback (☞ pg. 42, 43). • Close the cassette holder cover (☞ pg. 12).
36. The LCD monitor image is distorted.	36. • During playback of the unrecorded portion, High-speed Search and still playback, LCD monitor indications appear distorted. This is not a defect.	36. _____
37. Images on the LCD monitor are jittery.	37. • The speaker volume is too great.	37. • Turn the speaker volume down (☞ pg. 33).
38. Blocks of noise appear during playback, or there is no playback picture and the screen becomes blue.	38. _____	38. • Clean the video heads with an optional cleaning cassette (☞ pg. 78).
39. The LCD monitor, the viewfinder and the lens have become dirty (ex. fingerprints).	39. _____	39. • Wipe them gently with soft cloth. Wiping strongly can cause damage (☞ pg. 76).
40. An unusual mark appears.	40. _____	40. • Check the section of the manual that explains LCD monitor/viewfinder indications (☞ pg. 69 – 73).

CONTINUED ON NEXT PAGE

SYMPTOM	POSSIBLE CAUSES	CORRECTIVE ACTION
<p>41. An error indication (E01 — E06) appears.</p>	<p>41. • A malfunction of some kind has occurred. In this case the camcorder's functions become unusable.</p>	<p>41. • Remove the power supply (battery pack, etc.) and wait a few minutes for the indication to clear. When it does, you can resume using the camcorder. If the indication remains even though you repeat the above two or three times, please consult your nearest JVC dealer.</p>
<p>42. The charger indicator on the AC Power Adapter/Charger does not light.</p>	<p>42. • The temperature of the battery is extremely high/low. • Charging is difficult in places subject to extremely high/low temperatures.</p>	<p>42. • To protect the battery, it is recommended to charge it in places with a temperature of 10°C to 35°C (50°F to 95°F) (☞ pg. 77).</p>
<p>43. Picture does not appear on the LCD monitor.</p>	<p>43. • The lens cap is attached. • The LCD monitor's brightness setting is too dark.</p>	<p>43. • Remove the lens cap (☞ pg. 16). • Adjust the brightness of the LCD monitor (☞ pg. 16). • If the monitor is tilted upward 180 degrees, open the monitor fully (☞ pg. 17).</p>
<p>44. When the image is printed from the printer, a black bar appears at the bottom of the screen.</p>	<p>44. • This is not a malfunction.</p>	<p>44. • By recording with "DIS" activated (☞ pg. 26) this can be avoided.</p>
<p>45. When the camcorder is connected via the DV connector, the camcorder does not operate.</p>	<p>45. • The DV cable was plugged/unplugged with power turned on.</p>	<p>45. • Turn the camcorder's power off and on again, then operate it.</p>

LCD Monitor/Viewfinder Indications During Video Recording Only

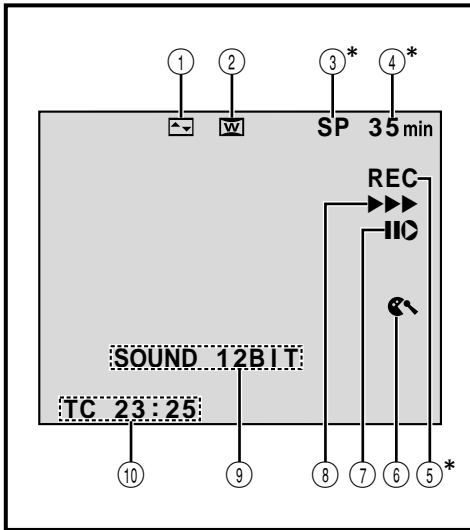

* Setting "ON SCREEN" to "SIMPLE" in the Menu Screen removes indications marked with * from the screen (☞ pg. 27, 34).

No.	Function
①	Displays the selected Fade/Wipe effect. (☞ pg. 28, 29)
②	Appears when in the Squeeze or Cinema mode. (☞ pg. 26)
③*	Displays the recording mode (SP or LP). (☞ pg. 13)
④*	Displays the tape remaining time. (☞ pg. 16)
⑤*	<ul style="list-style-type: none"> • "REC" appears during recording. • "PAUSE" appears during Record-Standby mode. (☞ pg. 16)
⑥	Appears when the wind cut mode is engaged to cut down on noise created by wind. (☞ pg. 27)
⑦	Appears when the Insert Editing (IIC) or Insert Editing Pause (IIC) mode is engaged. (☞ pg. 61)
⑧	Appears while the tape is running. (☞ pg. 16)
⑨	Displays the sound mode for approx. 5 seconds after turning on the camcorder. (☞ pg. 25)
⑩	Displays the Time Code. (☞ pg. 21, 27)



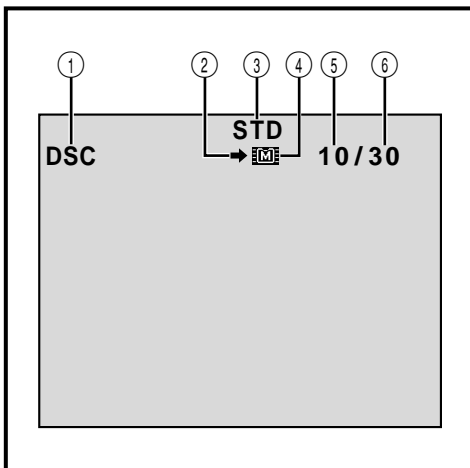





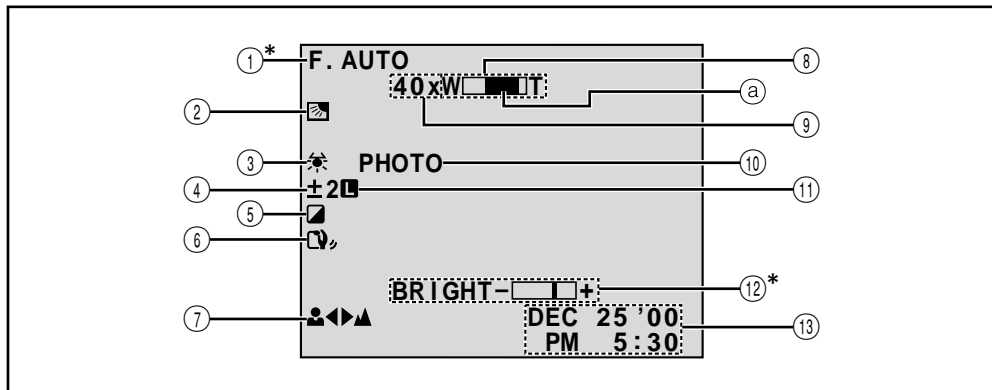







LCD Monitor/Viewfinder Indications During D.S.C. Recording Only



No.	Function
①	Appears when the VIDEO/DSC Switch is set to "DSC" and the Power Switch is set to "A" or "M". (☞ pg. 15, 19)
②	Appears and blinks during shooting. (☞ pg. 19)
③	Displays the Picture Quality mode of the stored image. There are 2 modes available: FINE and STD (Standard). (☞ pg. 14, 19)
④	Appears during shooting. (☞ pg. 19)
⑤	Displays the number of images that have already been shot. (☞ pg. 19)
⑥	Displays the total number of shots that can be stored, including those already taken. (☞ pg. 19)

LCD Monitor/Viewfinder Indications During Both Video And D.S.C. Recording



No.	Function	
①*	Appears when the power switch is set to "  ".	( pg. 15)
②	Appears when backlight compensation is used.	( pg. 31)
③	Appears when the white balance is adjusted.	( pg. 32)
④	Appears when the exposure is adjusted.	( pg. 31)
⑤	Displays the selected Program AE with special effects.	( pg. 30)
⑥	Appears when Digital Image Stabilizer ("DIS") is engaged.	( pg. 26)
⑦	Appears when the focus is adjusted manually.	( pg. 23)
⑧	Appears during zooming. ⓐ Zoom level indicator	( pg. 20)
⑨	<ul style="list-style-type: none"> • Approximate zoom ratio: Appears during zooming. •  : Appears when "GAIN UP" is set to "AUTO" and the shutter speed is automatically adjusted. 	( pg. 20) ( pg. 25)
⑩	Appears when taking a Snapshot.	( pg. 18, 19)
⑪	Appears when the iris is locked.	( pg. 31)
⑫*	Displays the brightness of the LCD monitor.	( pg. 16)
⑬	Displays the date/time.	( pg. 11)

* Setting "ON SCREEN" to "SIMPLE" in the Menu Screen removes indications marked with * from the screen ( pg. 27, 34).

LCD Monitor/Viewfinder Indications During Video Playback

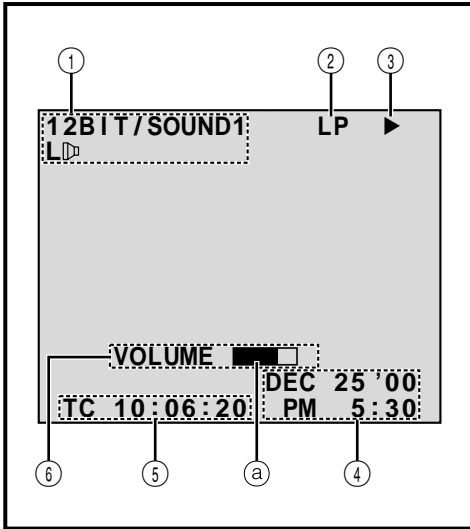



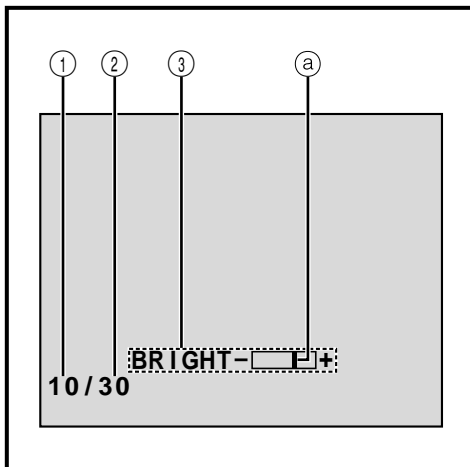

No.	Function
①	Displays the sound mode. (☞ pg. 34, 35)
②	Displays the tape speed. (☞ pg. 13)
③	Appears while a tape is running. ▶ : Playback ▶▶ : Fast-Forward/Shuttle search ◀◀ : Rewind/Shuttle search : Pause ▶ : Forward slow-motion ◀ : Reverse slow-motion ◐ : Audio Dubbing ◐◐ : Audio Dubbing Pause
④	Displays the date/time. (☞ pg. 34, 35)
⑤	Displays the time code. (☞ pg. 34, 35)
⑥	BRIGHT : Displays the brightness of the LCD monitor. (☞ pg. 16) VOLUME : Displays the speaker volume. (☞ pg. 33) Ⓐ The level indicator moves.

LCD Monitor/Viewfinder Indications During D.S.C. Playback

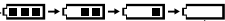
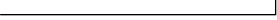

No.	Function
①	Displays the index number of the image file. (☞ pg. 36)
②	Displays the total number of stored images. (☞ pg. 36)
③	Displays the brightness of the LCD monitor or the viewfinder. (☞ pg. 16) Ⓐ The level indicator moves.







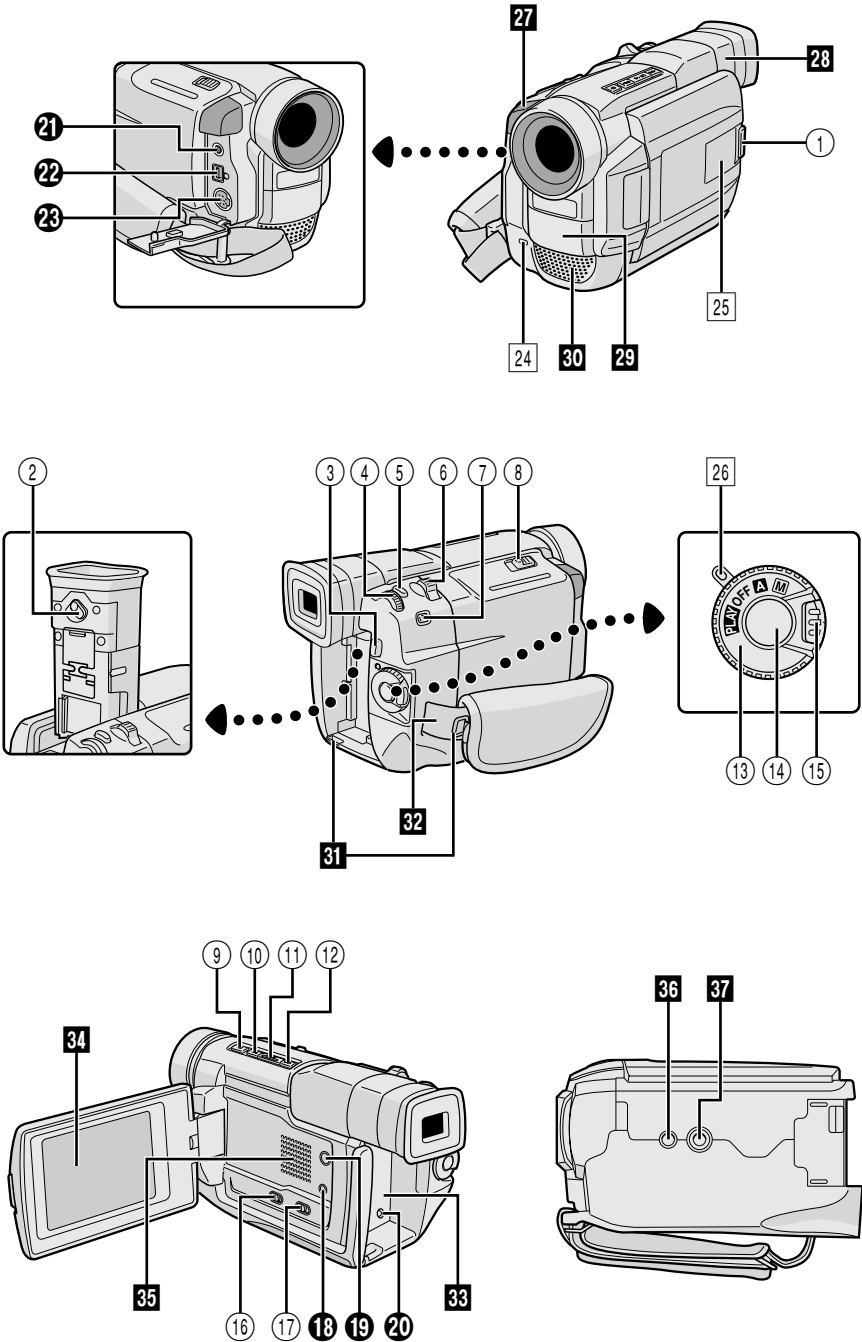













Warning Indications

Indications	Function
	<p>Displays the battery remaining power.</p> <p>Remaining power level: high </p> <p>Remaining power level: exhausted </p> <p>As the battery power comes close to nil, the battery indicator  blinks. When the battery power is exhausted, power turns off automatically.</p>
	<p>Appears when no tape is loaded. (pg. 12)</p>
<p>CHECK TAPE'S ERASE PROTECTION SWITCH</p>	<p>Appears when the erase protection tab is set to "SAVE" while the Power Switch is set to "A" or "M" and the VIDEO/DSC Switch is set to "VIDEO". (pg. 12)</p>
<p></p> <p>HEAD CLEANING REQUIRED USE CLEANING CASSETTE</p>	<p>Appears if dirt is detected on the heads. Use an optional cleaning cassette. (pg. 78)</p>
<p></p> <p>CONDENSATION, OPERATION PAUSED PLEASE WAIT</p>	<p>Appears if condensation occurs. When this indication is displayed, wait more than 1 hour until condensation disappears.</p>
<p>TAPE!</p>	<p>Appears if a tape is not loaded when the Recording Start/Stop Button or SNAPSHOT Button is pressed while the Power Switch is set to "A" or "M" and the VIDEO/DSC Switch is set to "VIDEO".</p>
<p>TAPE END</p>	<p>Appears when the tape ends during recording or playback. (pg. 17)</p>
<p>DIFFERENT FORMATTED TAPE</p>	<p>Appears if a tape in another format is loaded.</p>







Indications	Function
SET DATE/TIME!	<ul style="list-style-type: none"> ● Appears when the date/time is not set. (pg. 11) ● Appears when the built-in clock battery runs out and the previously set date/time is erased. Consult your nearest JVC dealer for replacement.
LENS CAP	Appears for 5 seconds after power is turned on if the lens cap is attached.
A. DUB ERROR!	<ul style="list-style-type: none"> ● Appears if Audio Dubbing is attempted on a blank portion of a tape. (pg. 60)
A. DUB ERROR! <CANNOT DUB ON AN LP RECORDED TAPE> <CANNOT DUB ON A 16BIT RECORDING> <CHECK TAPE'S ERASE PROTECTION SWITCH>	<ul style="list-style-type: none"> ● Appears if Audio Dubbing is attempted on a tape recorded in the LP mode. (pg. 60) ● Appears if Audio Dubbing is attempted on a tape recorded in 16-bit audio. (pg. 60) ● Appears if A. DUB (⊖) on the remote control is pressed when the erase protection tab is set to "SAVE". (pg. 60)
INSERT ERROR!	<ul style="list-style-type: none"> ● Appears if Insert Editing is attempted on a blank portion of a tape. (pg. 61)
INSERT ERROR! <CANNOT EDIT ON AN LP RECORDED TAPE> <CHECK TAPE'S ERASE PROTECTION SWITCH>	<ul style="list-style-type: none"> ● Appears if Insert Editing is attempted on a tape recorded in the LP mode. (pg. 61) ● Appears if INSERT (⊙) on the remote control is pressed when the erase protection tab is set to "SAVE". (pg. 61)
MEMORY IS FULL	Appears when the built-in memory is full and shooting is not possible.
COPYING FAILED	<ul style="list-style-type: none"> ● Appears if dubbing of copyguarded signals is attempted while this camcorder is being used as a recorder. ● Appears if the built-in memory is full when dubbing still images recorded on the tape to the built-in memory. (pg. 49) ● Appears in the following cases when dubbing still images stored in the built-in memory to a tape: <ul style="list-style-type: none"> – when condensation occurs. – when no tape is loaded. – when the erase protection tab is set to "SAVE". – when a tape in another format is loaded. – when the tape ends. (pg. 48)
NO IMAGES STORED	Appears if there are no images stored in the built-in memory when the Power Switch is set to "PLAY" and the VIDEO/DSC Switch is set to "DSC".
E01 — E06 UNIT IN SAFEGUARD MODE REMOVE AND REATTACH BATTERY	The error indications (E01 — E06) show what type of malfunction has occurred. When an error indication appears, the camcorder turns off automatically. Remove the power supply (battery, etc.) and wait a few minutes for the indication to clear. When it does, you can resume using the camcorder. If the indication remains, consult your nearest JVC dealer.





Controls

- ① Monitor Open Button
[PUSH OPEN]  pg. 16
- ② Diopter Adjustment Control  pg. 10
- ③ Battery Release Button
[BATTERY RELEASE]  pg. 9
- ④ • MENU Wheel [+ , - , PUSH]  pg. 24
• LCD Monitor BRIGHT
(Brightness) Control [+ , -]  pg. 16
- ⑤ Snapshot Button
[SNAPSHOT]  pg. 18, 19, 49
- ⑥ • Power Zoom Lever [T/W]  pg. 20
• Speaker Volume Control [VOL.]  pg. 33
- ⑦ Snapshot Mode Button
[MODE]  pg. 18, 19
- ⑧ OPEN/EJECT Switch  pg. 12
- ⑨ Stop Button [■]  pg. 33
- ⑩ • Rewind Button [◀◀]  pg. 33
• BACKLIGHT Button  pg. 31
- ⑪ Play/Pause Button [▶/||]  pg. 33
- ⑫ • Fast-Forward Button [▶▶]  pg. 33
• FOCUS Button  pg. 23
- ⑬ Power Switch
[A, M, **PLAY**, OFF]  pg. 15
- ⑭ Recording Start/Stop Button  pg. 16
- ⑮ Lock Button  pg. 15
- ⑯ VIDEO/DSC Switch [VIDEO, **DSC**]  pg. 15
- ⑰ Video Light Switch
[LIGHT OFF/AUTO/ON]  pg. 22











Connectors

- To connect cables to the following connectors **18** and **19**, open the LCD monitor.
- 18** PC (DIGITAL PHOTO) Connector  pg. 44
 - 19** J Terminal/Edit Connector [JLIP (Joint Level Interface Protocol)/EDIT]  pg. 55
 - Connect the editing cable when performing Random Assemble Editing.
 - Connect to a JLIP-compatible camcorder or VCR to control it from the computer using the provided Software.
 - 20** DC Input Connector  pg. 9
- The connectors **21** to **23** are located beneath a cover.
- 21** Audio/Video Output Connector
[AV]  pg. 42, 46, 55
 - 22** Digital Video Connector [DV IN/OUT (i.link*)]  pg. 44, 45, 47
* i.Link refers to the IEEE1394-1995 industry specification and extensions thereof. The  logo is used for products compliant with the i.Link standard.
 - 23** S-Video Output Connector [S] ...  pg. 42, 46, 55

Indicators

- 24** Tally Lamp  pg. 16
- 25** Side LED Indicator  pg. 26
- 26** Power Lamp  pg. 16

Other Parts

- 27** • Remote Sensor  pg. 50
• Camera Sensor
Be careful not to cover this area, a sensor necessary for shooting is built-in here.
- 28** Viewfinder  pg. 10
- 29** Video Light  pg. 22
- 30** Stereo Microphone  pg. 60
- 31** Shoulder Strap Eyelets  pg. 10
- 32** Grip Strap  pg. 10
- 33** Battery Pack Mount  pg. 9
- 34** LCD Monitor  pg. 16, 17
- 35** Speaker  pg. 33
- 36** Stud Hole  pg. 10
- 37** Tripod Mounting Socket  pg. 10

After Use

- 1 Turn off the camcorder.
- 2 Slide and hold **OPEN/EJECT** in the direction of the arrow, then pull the cassette holder cover open until it locks. The cassette holder opens automatically. Remove the cassette.
- 3 Press "PUSH HERE" to close the cassette holder.
 - Once the cassette holder is closed, it recedes automatically. Wait until it recedes completely before closing the cassette holder cover.
- 4 Press **BATTERY RELEASE** and remove the battery pack.

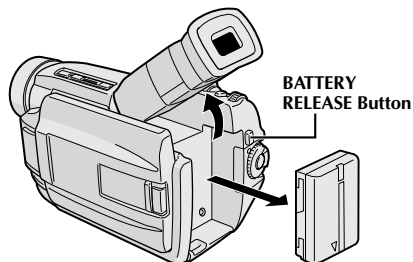
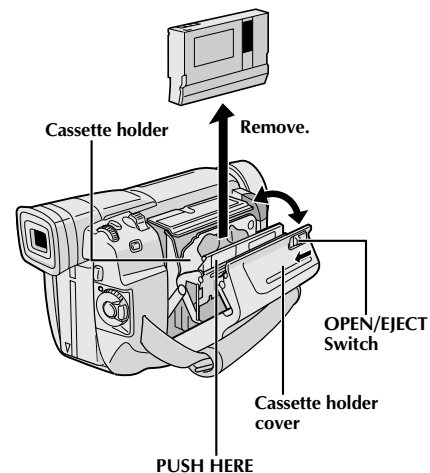

Cleaning The Camcorder

- 1 To clean the exterior, wipe gently with a soft cloth. Put the cloth in diluted mild soap and wring it well to wipe off heavy dirt. Then wipe again with a dry cloth.
- 2 Press **PUSH OPEN** and open the LCD monitor. Wipe gently with a soft cloth. Be careful not to damage the monitor. Close the LCD monitor.
- 3 To clean the lens, blow it with a blower brush, then wipe gently with lens cleaning paper.
- 4 To clean the viewfinder, raise it to the vertical position. Carefully open the cover on the bottom of the viewfinder ❶.
- 5 Insert a lens blower or soft cloth into the gap at the bottom of the viewfinder and clean the interior of the viewfinder with it ❷.
- 6 Close the cover. Tilt the viewfinder back to the horizontal position.

NOTES:

- Avoid using strong cleaning agents such as benzine or alcohol.
- Cleaning should be done only after the battery pack has been removed or other power units have been disconnected.
- Mold may form if the lens is left dirty.
- When using a cleaner or chemically treated cloth refer to the cautions of each product.

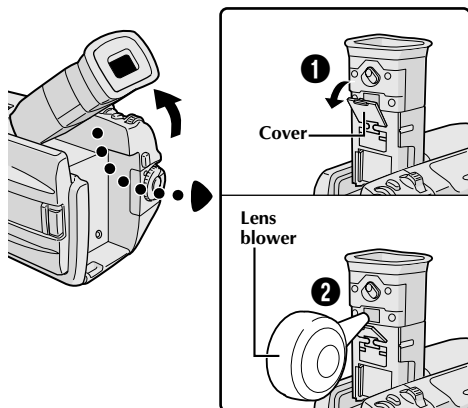

When using the AC Power Adapter/Charger in areas other than the USA

- The provided AC Power Adapter/Charger features automatic voltage selection in the AC range from 110 V to 240 V.

USING HOUSEHOLD AC PLUG ADAPTER

In case of connecting the unit's power cord to an AC wall outlet other than American National Standard C73 series type use an AC plug adapter, called a "Siemens Plug", as shown. For this AC plug adapter, consult your nearest JVC dealer.

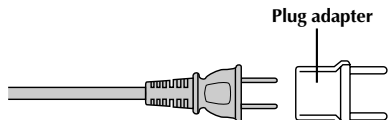

Video Light

DANGER

- The video light can become extremely hot. Do not touch it either while in operation or soon after turning it off, otherwise serious injury may result.
- Do not place the camcorder into the carrying case immediately after using the video light, since it remains extremely hot for some time.
- When operating, keep a distance of about 30 cm (11-13/16") between the video light and people or objects.
- Do not use near flammable or explosive materials.
- It is recommended that you consult your nearest JVC dealer for replacing the video light.



General Battery Precautions

If the remote control is not functioning even if it is being operated correctly, the batteries are exhausted. Replace them with fresh ones.

Use only the following batteries: AAA (R03) size x 2
Please make note of the following rules for battery use. When misused, the batteries can leak or explode.

1. When replacing batteries, refer to page 50.
2. **Do not** use any different size of batteries from those specified.
3. Be sure to install batteries in the correct direction.
4. **Do not** use rechargeable batteries.
5. **Do not** expose the batteries to excessive heat as they can leak or explode.
6. **Do not** dispose of the batteries in a fire.
7. Remove the batteries from the unit if it is to be stored for an extended period to avoid battery leakage which can cause malfunctions.

Battery Packs

The supplied battery pack is a lithium-ion battery. Before using the supplied battery pack or an optional battery pack, be sure to read the following cautions:

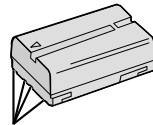

Terminals

1. To avoid hazards . . .

- **do not** burn.
- **do not** short-circuit the terminals. When transporting, make sure the provided battery cap is attached to the battery. If the battery cap is misplaced, carry the battery in a plastic bag.
- **do not** modify or disassemble.
- **do not** expose the battery to temperatures exceeding 60°C (140°F), as this may cause the battery to overheat, explode or catch fire.
- use only specified chargers.

2. To prevent damage and prolong service life . . .

- **do not** subject to unnecessary shock.
- charge in an environment where temperatures are within the tolerances shown in the chart below. This is a chemical reaction type battery—cooler temperatures impede chemical reaction, while warmer temperatures can prevent complete charging.
- store in a cool, dry place. Extended exposure to high temperatures will increase natural discharge and shorten service life.
- fully charge and then fully discharge the battery every 6 months when storing the battery pack over a long period time.
- remove from charger or powered unit when not in use, as some machines use current even when switched off.

NOTES:

- It is normal for the battery pack to be warm after charging, or after use.

Temperature Range Specifications

Charging 10°C to 35°C (50°F to 95°F)
Operation 0°C to 40°C (32°F to 104°F)
Storage -10°C to 30°C (14°F to 86°F)

- Recharging time is based on room temperature of 20°C (68°F).
- The lower the temperature, the longer recharging takes.

Cassettes

To properly use and store your cassettes, be sure to read the following cautions:

1. During use . . .

- make sure the cassette bears the Mini DV mark.
- be aware that recording onto prerecorded tapes automatically erases the previously recorded video and audio signals.
- make sure the cassette is positioned properly when inserting.

- do not load and unload the cassette repeatedly without allowing the tape to run at all. This slackens the tape and can result in damage.
- do not open the front tape cover. This exposes the tape to fingerprints and dust.

2. Store cassettes . . .

- away from heaters or other heat sources.
- out of direct sunlight.
- where they won't be subject to unnecessary shock or vibration.
- where they won't be exposed to strong magnetic fields (such as those generated by motors, transformers or magnets).
- vertically, in their original cases.

LCD Monitor

1. To prevent damage to the LCD monitor, DO NOT . . .

- push it strongly or apply any shocks.
- place the camcorder with the LCD monitor on the bottom.

2. To prolong service life . . .

- avoid rubbing it with coarse cloth.

3. Be aware of the following phenomena for LCD monitor use.

These are not malfunctions:

- While using the camcorder, the surface around the LCD monitor and/or the back of the LCD monitor may heat up.
- If you leave power on for a long time, the surface around the LCD monitor becomes hot.

Main Unit

1. For safety, DO NOT . . .

- open the camcorder's chassis.
- disassemble or modify the unit.
- short-circuit the terminals of the battery pack.
 - Keep it away from metallic objects when not in use.
- allow inflammables, water or metallic objects to enter the unit.
- remove the battery pack or disconnect the power supply while the power is on.
- leave the battery pack attached when the camcorder is not in use.

2. Avoid using the unit . . .

- in places subject to excessive humidity or dust.
- in places subject to soot or steam such as near a cooking stove.
- in places subject to excessive shock or vibration.
- near a television set.

- near appliances generating strong magnetic or electric fields (speakers, broadcasting antennas, etc.).
- in places subject to extremely high (over 40°C or 104°F) or extremely low (under 0°C or 32°F) temperatures.

3. DO NOT leave the unit . . .

- in places of over 50°C (122°F).
- in places where humidity is extremely low (below 35%) or extremely high (above 80%).
- in direct sunlight.
- in a closed car in summer.
- near a heater.

4. To protect the unit, DO NOT . . .

- allow it to become wet.
- drop the unit or strike it against hard objects.
- subject it to shock or excessive vibration during transportation.
- keep the lens directed at extremely bright objects for long periods.
- expose the lens to direct sunlight.
- carry it by holding the LCD monitor or the viewfinder.
- swing it excessively when using the shoulder strap or the grip.

5. Dirty heads can cause the following problems:

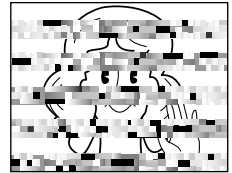
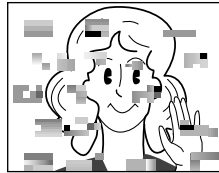

- No picture during playback.
- Blocks of noise appear during playback.
- During recording, the Head Clog Warning indicator "⊗" appears.

In such cases, use an optional cleaning cassette. Insert it and play back. If the cassette is used more than once consecutively, damage to the video heads may result. After the camcorder plays back for about 20 seconds, it stops automatically. Also refer to the cleaning cassette's instructions.

If, after using the cleaning cassette, the problems still exist, consult your nearest JVC dealer. Mechanical moving parts used to move the video heads and video tape tend to become dirty and worn out over time. In order to maintain a clear picture at all times, periodic check-ups are recommended after using the unit for about 1,000 hours. For periodic check-ups please consult your nearest JVC dealer.

How To Handle A CD-ROM

- Take care not to soil or scratch the mirror surface (opposite to the printed surface). Do not write anything or put a sticker on either the front or back surface. If the CD-ROM gets dirty, gently wipe it with a soft cloth outward from the center hole using a circular motion.
- Do not use conventional disc cleaners or cleaning spray.
- Do not bend the CD-ROM or touch its mirror surface.
- Do not store your CD-ROM in a dusty, hot or humid environment. Keep it away from direct sunlight.

About moisture condensation . . .

- You have observed that pouring a cold liquid into a glass will cause drops of water to form on the glass' outer surface. This same phenomenon occurs on the head drum of a camcorder when it is moved from a cool place to a warm place, after heating a cold room, under extremely humid conditions or in a place directly subjected to the cool air from an air conditioner.
- Moisture on the head drum can cause severe damage to the video tape, and can lead to internal damage to the camcorder itself.

Serious malfunctioning

If malfunctioning occurs, stop using the unit immediately and consult your local JVC dealer.

The camcorder is a microcomputer-controlled device. External noise and interference (from a TV, a radio, etc.) might prevent it from functioning properly. In such cases, first disconnect its power supply unit (battery pack, AC Power Adapter/Battery Charger, etc.) and wait a few minutes and then re-connect it and proceed as usual from the beginning.

Declaration of Conformity

Model Number : GR-DVL805U/505U
Trade Name : JVC
Responsible party : JVC AMERICAS CORP.
Address : 1700 Valley Road Wayne,
 N. J. 07470
Telephone Number : 973-315-5000

This device complies with Part 15 of FCC Rules. Operation is subject to the following two conditions:

(1) This device may not cause harmful interference, and (2) this device must accept any interference received, including interference that may cause undesired operation.





Change or modifications not approved by the party responsible for compliance could void the user's authority to operate the equipment. This equipment has been tested and found to comply with the limits for a Class B digital device, pursuant to Part 15 of the FCC Rules. These limits are designed to provide reasonable protection against harmful interference in a residential installation. This equipment generates, uses, and can radiate radio frequency energy and, if not installed and used in accordance with the instructions, may cause harmful interference to radio communications. However, there is no guarantee that interference will not occur in a particular installation. If this equipment does cause harmful interference to radio or television reception, which can be determined by turning the equipment off and on, the user is encouraged to try to correct the interference by one or more of the following measures:

- Reorient or relocate the receiving antenna.
- Increase the separation between the equipment and receiver.
- Connect the equipment into an outlet on a circuit different from that to which the receiver is connected.
- Consult the dealer or an experienced radio/TV technician for help.





This Class B digital apparatus complies with Canadian ICES-003.

Cet appareil numérique de la classe B est conforme à la norme NMB-003 du Canada.







A

- AC Power Adapter/Charger  pg. 8, 9
- Audio Dubbing  pg. 60
- Auto Focus  pg. 23
- Auto Shut off  pg. 17, 19, 33









B

- Backlight Compensation  pg. 31
- Battery Low  pg. 72
- Battery Pack  pg. 8, 9, 77
- Brighten The LCD Monitor  pg. 16



C

- Channels (Left/Right)  pg. 35
- Charge The Battery Pack  pg. 8
- Cinema  pg. 26
- Classic Film  pg. 30
- Clean The Camcorder  pg. 76
- Connections  pg. 9, 42, 44 – 47, 55



D

- Darken The LCD Monitor  pg. 16
- Date/Time Display  pg. 27, 34, 35
- Date/Time Settings  pg. 11
- Deleting Images  pg. 40
- Demonstration Mode  pg. 7, 26
- Digital Zoom  pg. 20, 25
- DIS (Digital Image Stabilizer)  pg. 26
- Diopter Adjustment  pg. 10
- Dubbing  pg. 46 – 49



E

- Erase Protection  pg. 12
- Exposure Control  pg. 31



F

- Fade-In/Out  pg. 28, 29
- Fast-Forward The Tape  pg. 33
- Frame-By-Frame Playback  pg. 33, 52

G

- Gain Up  pg. 25
- Grip Adjustment  pg. 10



I

- Icons  pg. 25 – 27
- Index Playback  pg. 37
- Index Screen  pg. 37
- Insert Editing  pg. 61
- Iris  pg. 31
- Iris Lock  pg. 31







J

- Journalistic Shooting  pg. 17

L

- LCD monitor/Viewfinder
 - Indications  pg. 69 – 73
- Load A Tape  pg. 12

M

- Manual Focus  pg. 23
- Menu Screen, CAMERA MENU  pg. 25, 26
- Menu Screen, DISPLAY MENU  pg. 27, 34
- Menu Screen, DSC MENU  pg. 27, 39
- Menu Screen, MANUAL MENU  pg. 26, 27
- Menu Screen, VIDEO MENU  pg. 34
- Monotone  pg. 30

P

Picture Quality Mode	☞ pg. 14
Picture Wipe/Dissolve	☞ pg. 28, 29
Playback Special Effects	☞ pg. 53
Playback Zoom	☞ pg. 52
Power Switch Position	☞ pg. 15
Printer	☞ pg. 45
Program AE With Special Effects	☞ pg. 30
Protecting Images	☞ pg. 39
Provided Accessories	☞ pg. 6

R

Random Assemble Editing	☞ pg. 54 – 59
Record-Standby	☞ pg. 16
Recording Mode	☞ pg. 13
Remote Control	☞ pg. 50
Reset	☞ pg. 27
Rewind The Tape	☞ pg. 33

S

Self-Recording	☞ pg. 17
Sepia	☞ pg. 30
Set Remote Control/VCR Code	☞ pg. 54
Shuttle Search	☞ pg. 33
Shutter Speed	☞ pg. 30
Slide Show	☞ pg. 38
Slow-Motion Playback	☞ pg. 52
Slow Shutter	☞ pg. 30
Snapshot	☞ pg. 18, 19
Snapshot Mode	☞ pg. 18
Sound Mode	☞ pg. 25, 34, 35
Speaker Volume	☞ pg. 33
Specifications	☞ pg. 82, 83
Squeeze	☞ pg. 26
Still Playback	☞ pg. 33
Strobe	☞ pg. 30

T

Tally	☞ pg. 16, 25
Tele Macro	☞ pg. 26
Time Code	☞ pg. 21, 27, 34, 35
Tripod Mounting	☞ pg. 10
Twilight	☞ pg. 30

U

Unload A Tape	☞ pg. 12
---------------------	----------

V

VIDEO/DSC Switch Position	☞ pg. 15
Video Echo	☞ pg. 30
Video Light	☞ pg. 22

W



White Balance	☞ pg. 32
Wide Mode	☞ pg. 26
Wind Cut	☞ pg. 27
Wipe In/Out	☞ pg. 28, 29

Z

Zooming	☞ pg. 20
---------------	----------

Camcorder

For General

Power supply	: DC 6.3 V  (Using AC Power Adapter/Charger) DC 7.2 V  (Using battery pack)
Power consumption	
LCD monitor off, viewfinder on	: Approx. 4.3 W
LCD monitor on, viewfinder off	: Approx. 5.3 W
Video light	: Approx. 3.5 W
Dimensions (W x H x D)	: 80 mm x 96 mm x 159 mm (3-3/16" x 3-13/16" x 6-5/16") (with the LCD monitor closed and the viewfinder pushed down)
Weight	: Approx. 580 g (1.3 lbs)
Operating temperature	: 0°C to 40°C (32°F to 104°F)
Operating humidity	: 35% to 80%
Storage temperature	: -20°C to 50°C (-4°F to 122°F)
Pickup	: 1/4" CCD
Lens	: F 1.8, f = 3.6 mm to 36 mm, 10:1 power zoom lens
Filter diameter	: ø37 mm
LCD monitor	
GR-DVL805	: 3.5" diagonally measured, LCD panel/TFT active matrix system
GR-DVL505	: 3.0" diagonally measured, LCD panel/TFT active matrix system
Viewfinder	
GR-DVL805	: Electronic viewfinder with 0.44" color LCD
GR-DVL505	: Electronic viewfinder with 0.24" black/white LCD
Speaker	: Monaural

For Digital Video Camera

Format	: DV format (SD mode)
Signal format	: NTSC standard
Recording/Playback format	: Video: Digital component recording : Audio: PCM digital recording, 32 kHz 4-channel (12-bit), 48 kHz 2-channel (16-bit)
Cassette	: Mini DV cassette
Tape speed	: SP: 18.8 mm/s LP: 12.5 mm/s
Maximum recording time (using 80 min. cassette)	: SP: 80 min. LP: 120 min.

For Digital Still Camera

Storage media	: Built-in flash memory, 2 Mbyte
Compression system	: JPEG (compatible)
File size	: VGA: 640 x 480 pixels
Picture quality	: 2 modes (FINE/STANDARD)
Approximate number of storable images	
FINE	: 30
STANDARD	: 60

For Connectors

S	: Y : 1 V (p-p), 75 Ω , analog output C : 0.29 V (p-p), 75 Ω , analog output
AV	
Video output	: 1 V (p-p), 75 Ω , analog
Audio output	: 300 mV (rms), 1 k Ω , analog, stereo
DV	
Input/output	: 4-pin, IEEE 1394 compliant
PC (DIGITAL PHOTO)	
Digital still output	: \varnothing 2.5 mm, 3-pole
JLIP/EDIT	: \varnothing 3.5 mm, 4-pole

AC Power Adapter/Charger AA-V40U

Power requirement	
U.S.A. and Canada	: AC 120 V \sim , 60 Hz
Other countries	: AC 110 V to 240 V \sim , 50 Hz/60 Hz
Power consumption	: 23 W
Output	
Charge	: DC 7.2 V \equiv , 1.2 A
VTR	: DC 6.3 V \equiv , 1.8 A
Dimensions (W x H x D)	: 68 mm x 38 mm x 110 mm (2-11/16" x 1-1/2" x 4-3/8")
Weight	: Approx. 250 g (0.56 lbs)

Specifications shown are for SP mode unless otherwise indicated. E & O.E. Design and specifications subject to change without notice.

EN

**GR-DVLR805
GR-DVLR505**

JVC

VICTOR COMPANY OF JAPAN, LIMITED